

## N Connectors

For HELIAX® FSJ4-50B Coaxial Cables

Bulletin 237554 Revision F Page 1 of 2

CommScope Infrastructure Academy offers installation training.

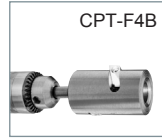

**1**

Trim cable jacket.  
 Recortar la envuelta del cable.  
 Coupez la gaine du câble.  
 Kabelmantel abziehen.  
 Retire a capa do cabo.  
 切整電纜外皮

**2**

Remove 7 mm of outer conductor.  
 Retirar 7 mm del conductor externo.  
 Enlevez 7 mm du conducteur extérieur.  
 7 mm des Außenleiters entfernen.  
 Remova 7 mm do condutor externo.  
 剝除外導體 7mm

**3**

Remove foam and adhesive.  
 Retirar el material de espuma y el adhesivo.  
 Enlevez la mousse et l'adhésif.  
 Verschäumung und Klebeband entfernen.  
 Remova a espuma e o adesivo.  
 去除泡沫塑料和粘潔劑

**4**

Taper inner conductor.  
 Dar forma cónica al conductor interno.  
 Effilez le conducteur intérieur.  
 Innenleiter abschrägen.  
 Atarraxe o condutor interno.  
 錐削內心導體

**5**

Remove debris.  
 Retirar los restos.  
 Enlevez les débris.  
 Metallspäne entfernen.  
 Remova os detritos.  
 去除殘渣

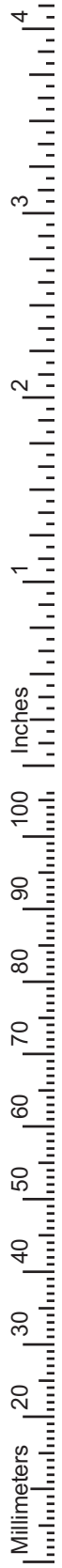

## N Connectors

For HELIAX® FSJ4-50B Coaxial Cables

Bulletin 237554 Revision F Page 2 of 2

CommScope Infrastructure Academy offers installation training.

6

Add grease and clamping nut.

Añadir la grasa y la tuerca sujetadora.

Ajoutez de la graisse et l'écrou de serrage.

Klemmutter vor Montage einfetten.

Acrescente graxa e a porca de aperto.

加油脂和緊固螺母

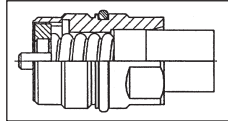
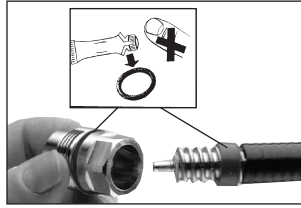

Thread clamping nut onto the cable until it stops as shown.

Roscar la tuerca sujetadora sobre el cable hasta que se detenga según lo indicado.

Insérez l'écrou de serrage sur le câble jusqu'à l'arrêt, comme illustré.

Klemmutter auf das Kabel setzen und bis zum Anschlag eindrehen.

Rosqueie a porca de aperto ao cabo até ela parar conforme indicado.

將緊固螺母擰到電纜上，直到擰不動為止，如圖示

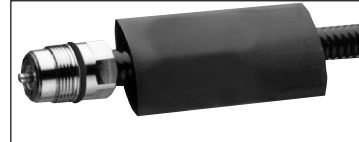

7

Attach connector body.

Añadir el cuerpo del conector.

Fixez le corps du connecteur.

Steckergehäuse befestigen.

Coloque o corpo do conector.

安裝接頭體

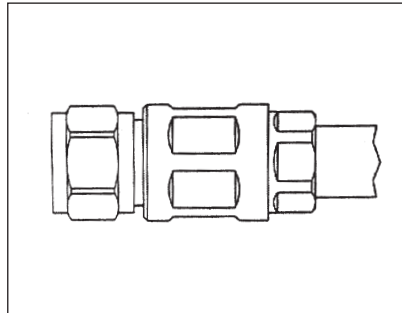
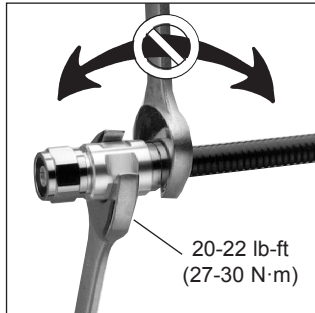

8

Apply heat shrink tube.

Aplicar el tubo de termocongrimiento.

Mettez en place la gaine thermorétractable.

Schrumpfschlauch überziehen.

Aqueça o tubo plástico.

加熱縮緊套管

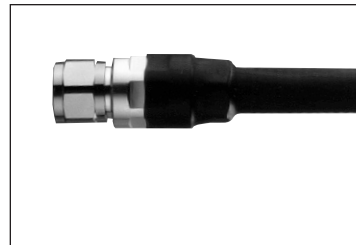

9

Coupling torque.

Par de acoplamiento.

Couple de serrage.

Anschlußdrehmoment.

Torque de conjugação.

配合扭矩

15 lb-in (1.7 N·m)

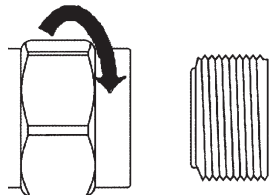

### CommScope

1100 CommScope Place SE P.O. Box 339, Hickory, NC 28603-0339  
(828) 324-2200 (800) 982-1708  
www.commscope.com

### Customer Service 24 hours

North America: +1-800-255-1479 (toll free)  
Any country: +1-779-435-6500  
email: acicustomersupportcenter@commscope.com

Notice: CommScope disclaims any liability or responsibility for the results of improper or unsafe installation, inspection, maintenance, or removal practices.

Aviso: CommScope no acepta ninguna obligación ni responsabilidad como resultado de prácticas incorrectas o peligrosas de instalación, inspección, mantenimiento o retiro.

Avis: CommScope décline toute responsabilité pour les conséquences de procédures d'installation, d'inspection, d'entretien ou de retrait incorrectes ou dangereuses.

Hinweis: CommScope lehnt jede Haftung oder Verantwortung für Schäden ab, die aufgrund unsachgemäßer Installation, Überprüfung, Wartung oder Demontage auftreten.

Atenção: A CommScope abdica do direito de toda responsabilidade pelos resultados de práticas inadequadas e sem segurança de instalação, inspeção, manutenção ou remoção.

Avvertenza: CommScope declina eventuali responsabilità derivanti dall'esecuzione di procedure di installazione, ispezione, manutenzione e smontaggio improprie o poco sicure.

注意: CommScope 公司申明對於不恰當或不安全的安裝、檢驗、維修或拆卸操作所導致的後果不負任何義務和責任

