

HTT-B2AG000000U000



NOVUX™ Prodigy™ Hardened Tap Terminal, 80/20, 12 dB, One Input port, 2 drop ports and one Through port, Stubless, with universal mounting bracket

- NOVUX™ Hardened Multi-fiber Terminals incorporate hardened connector technology that is designed to withstand the rugged outside plant environment
- Hardened connectors are factory-integrated and environmentally sealed for use in optical drop cable deployments
- Plug-and-play adapter ports ensure rapid cable installment in the outside plant access section of the network
- NOVUX™ Prodigy™ HTT Tap terminals are available in 2-port, 4-port and 8-port models, depending on the number of drop ports required. Each model is available with a range of tap values depending on how much optical power should be dropped off at each location
- HTT tap terminals are stubless with a Prodigy™ Input port and a Through Port for non-terminating taps
- NOVUX™ Prodigy™ smaller terminal size for aesthetics and allowing installation in constrained spaces
- NOVUX™ Prodigy™ terminals are available in Black (RAL# 9005) or Gray (RAL# 7035)
- CommScope Product ID plate with QR code link to product documents and C-Track

Product Classification

Regional Availability	Asia EMEA Latin America North America
Product Type	Access terminal, with tap
Product Brand	NOVUX™
Product Series	HTT
Minimum Order Quantity	1

General Specifications

Cable Type	No cable (stubless)
Distribution Type	2-port tap
Drop Port Type	Hardened Prodigy SC/APC
Enclosure Color	Black (RAL 9005)
Forward Port Type	Hardened Prodigy SC/APC
Forward Port, quantity	1
Input Tap, quantity	1
Mounting	Handhole Pedestal Pole Strand
Port Type	Hardened Prodigy SC/APC

HTT-B2AG000000U000

Split Ratio	80/20
Stub Type	No tail
Tap Ports, quantity	2
Thru Tap, quantity	1

Dimensions

Height	80.4 mm 3.17 in
Width	95.1 mm 3.74 in
Length	192.4 mm 7.58 in

Dimension Drawing

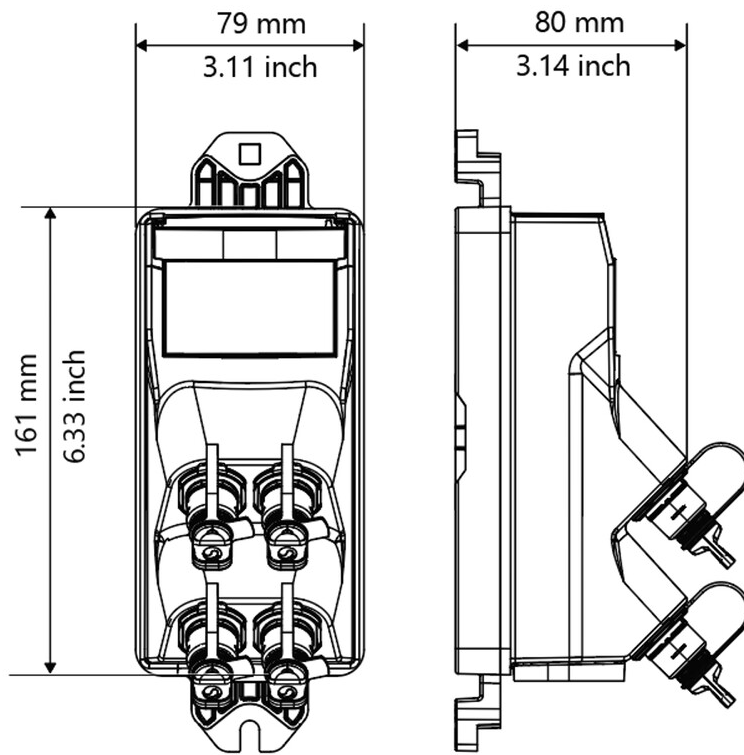

Ordering Tree

HTT-B2AG000000U000

Operating Wavelength Range	1260 – 1635 nm
Attenuation Terminal Connectors, maximum	0.4 dB
Tap Drop Loss, maximum	12.4 dB
Tap Thru Loss, maximum	2.1 dB
Tap Value	12 dB

Environmental Specifications

Operating Temperature	-40 °C to +65 °C (-40 °F to +149 °F)
Relative Humidity	5%–100%, condensing
Environmental Space	Above ground Below ground
Qualification Standards	IEC 60529, IP68 + 2 m waterhead IEC 61753-1, category G
UV Resistance	UV stabilized

Packaging and Weights

Included	Universal mounting bracket
Packaging quantity	1
Packaging Type	Box

Regulatory Compliance/Certifications

Agency	Classification
CHINA-ROHS	Below maximum concentration value
ISO 9001:2015	Designed, manufactured and/or distributed under this quality management system
REACH-SVHC	Compliant as per SVHC revision on www.commscope.com/ProductCompliance
ROHS	Compliant
UK-ROHS	Compliant

