

PM-238T-84

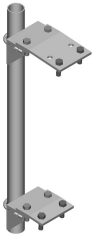

Adjustable Tapered Pipe Mount, 2-3/8 in OD x 84 in

Product Classification

Product Type Pipe mount

General Specifications

Mounting Saddle mounts

Note One 96 in x 8 in panel antenna per pipe mount

Pipe, quantity 1

Tower Taper Tapered

Dimensions

Height 2,133.6 mm | 84 in

Width 152.4 mm | 6 in

Length 152.4 mm | 6 in

Pipe Length 2,133.6 mm | 84 in

Pipe Outer Diameter 60.96 mm | 2.4 in

PM-238T-84

Outline Drawing

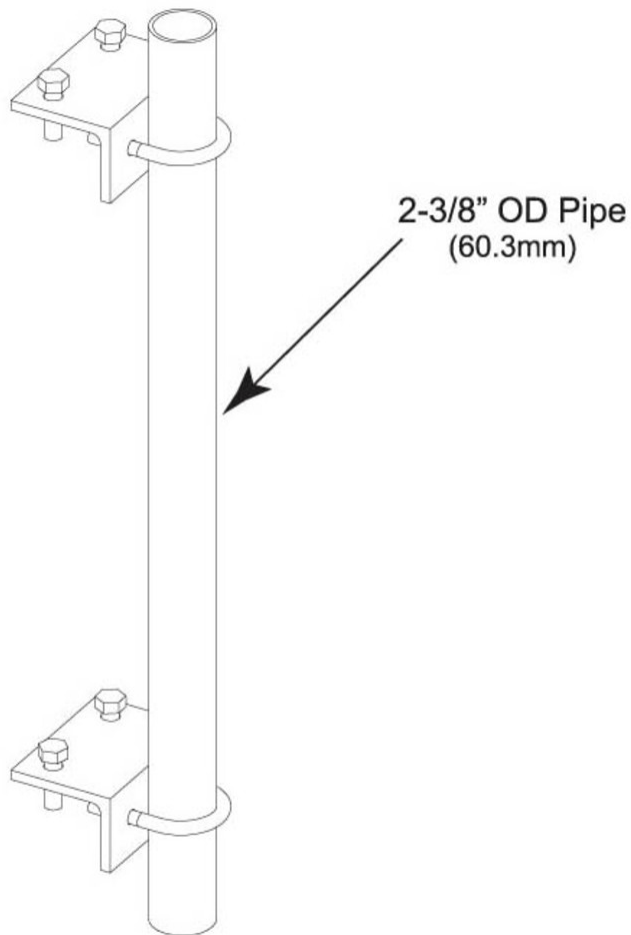

Material Specifications

Material Type Hot dip galvanized steel

Mechanical Specifications

Wind Rating 120 mph (BWS) at 150 ft AGL

Wind Rating Test Method TIA/EIA-222

Packaging and Weights

Included Brackets | Hardware | Pipe

Packaging quantity 1

PM-238T-84

Weight, net

11.8 kg | 26.015 lb

Regulatory Compliance/Certifications

Agency

ISO 9001:2015

Classification

Designed, manufactured and/or distributed under this quality management system



Included Products

- MT-651-84 - Plain End Pipe, 2-3/8 in OD x 84 in .120" A500C 46Ksi
- PM-TK - Pipe Mount Taper Kit

* Footnotes

Wind Rating

BWS—Base Wind Speed; FBC—Florida Building Code

MT-651-84



Plain End Pipe, 2-3/8 in OD x 84 in .120" A500C 46Ksi

Product Classification

Product Type Plain end pipe

General Specifications

Pipe, quantity 1

Dimensions

Height 60.96 mm | 2.4 in
Width 60.96 mm | 2.4 in
Length 2,133.6 mm | 84 in
Pipe Length 2,133.6 mm | 84 in
Pipe Outer Diameter 60.96 mm | 2.4 in
Material Thickness 3.048 mm | 0.12 in

Material Specifications

Material Type A500 | Hot dip galvanized steel
Material Grade C
Material Strength 46 kilopounds per square inch

Packaging and Weights

Included Pipe
Packaging quantity 1
Weight, net 9 kg | 19.842 lb

Regulatory Compliance/Certifications

Agency	Classification
CHINA-ROHS	Below maximum concentration value
ISO 9001:2015	Designed, manufactured and/or distributed under this quality management system

MT-651-84

REACH-SVHC	Compliant as per SVHC revision on www.commscope.com/ProductCompliance
ROHS	Compliant
UK-ROHS	Compliant



PM-TK

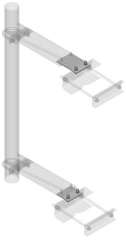

Pipe Mount Taper Kit

Product Classification

Product Type Pipe mount kit

General Specifications

Mounting Saddle mounts

Tower Taper Tapered

Dimensions

Height 25.4 mm | 1 in

Width 152.4 mm | 6 in

Length 152.4 mm | 6 in

PM-TK

Outline Drawing

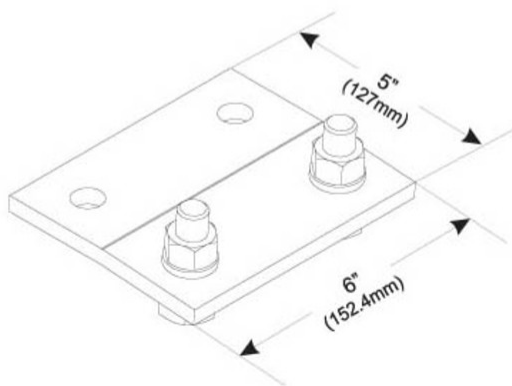
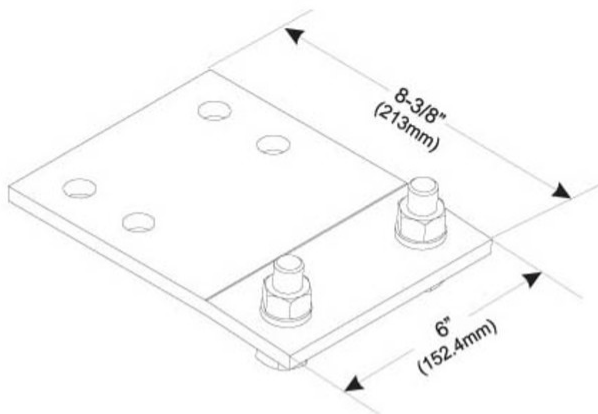

Material Specifications

Material Type Hot dip galvanized steel

Packaging and Weights

Included Hardware | Plates

Packaging quantity 1

Weight, net 4.2 kg | 9.259 lb

Regulatory Compliance/Certifications

Agency	Classification
--------	----------------

PM-TK

ISO 9001:2015	Designed, manufactured and/or distributed under this quality management system
REACH-SVHC	Compliant as per SVHC revision on www.commscope.com/ProductCompliance
ROHS	Compliant
UK-ROHS	Compliant

