

REV	MCO	DWN	DATE
A	20019792	TH	28-DEC-98
B	20235601	GRL	12-MAR-08

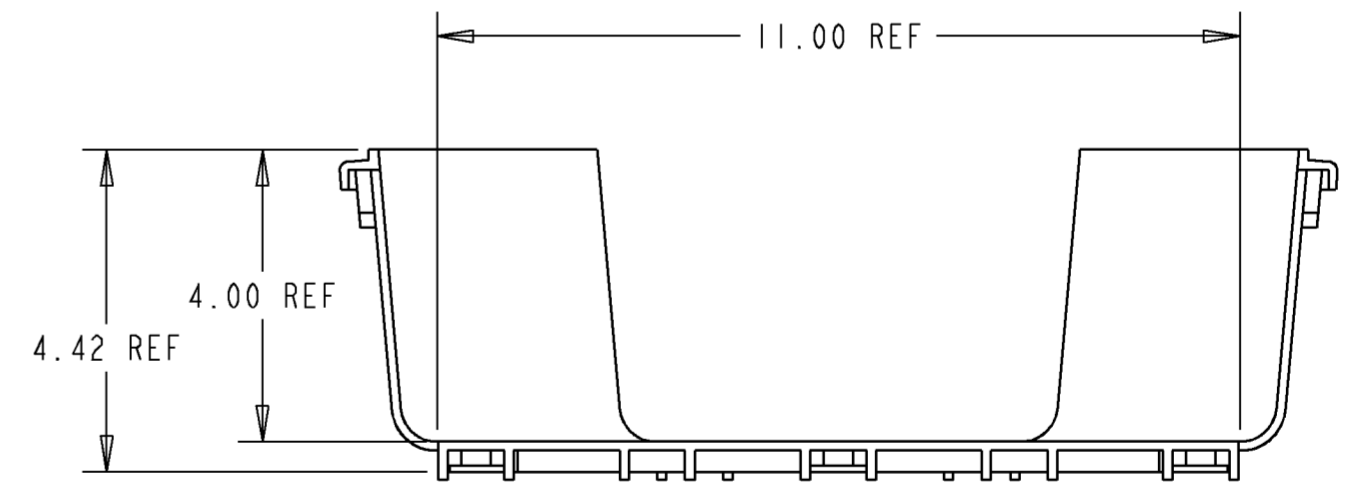
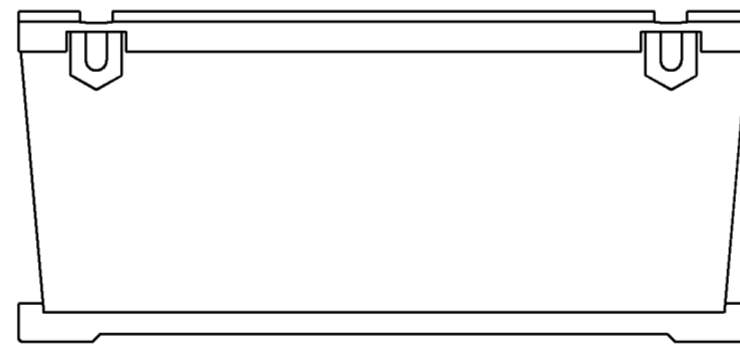
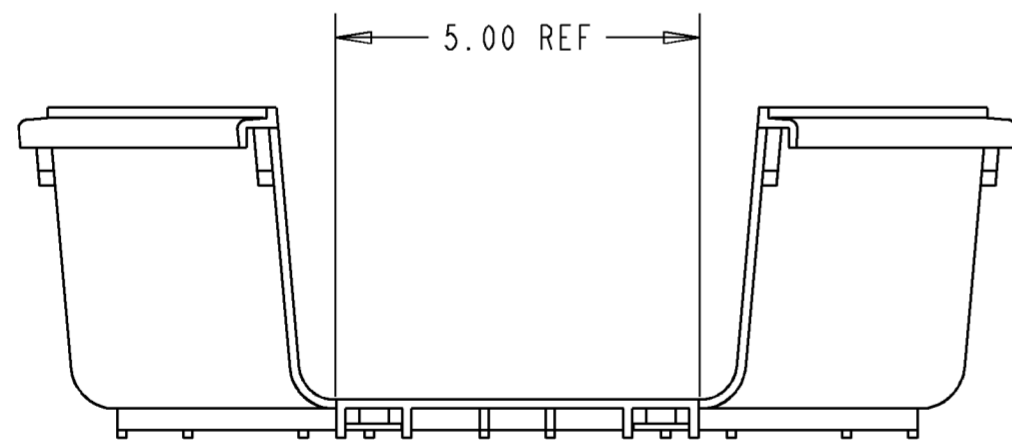
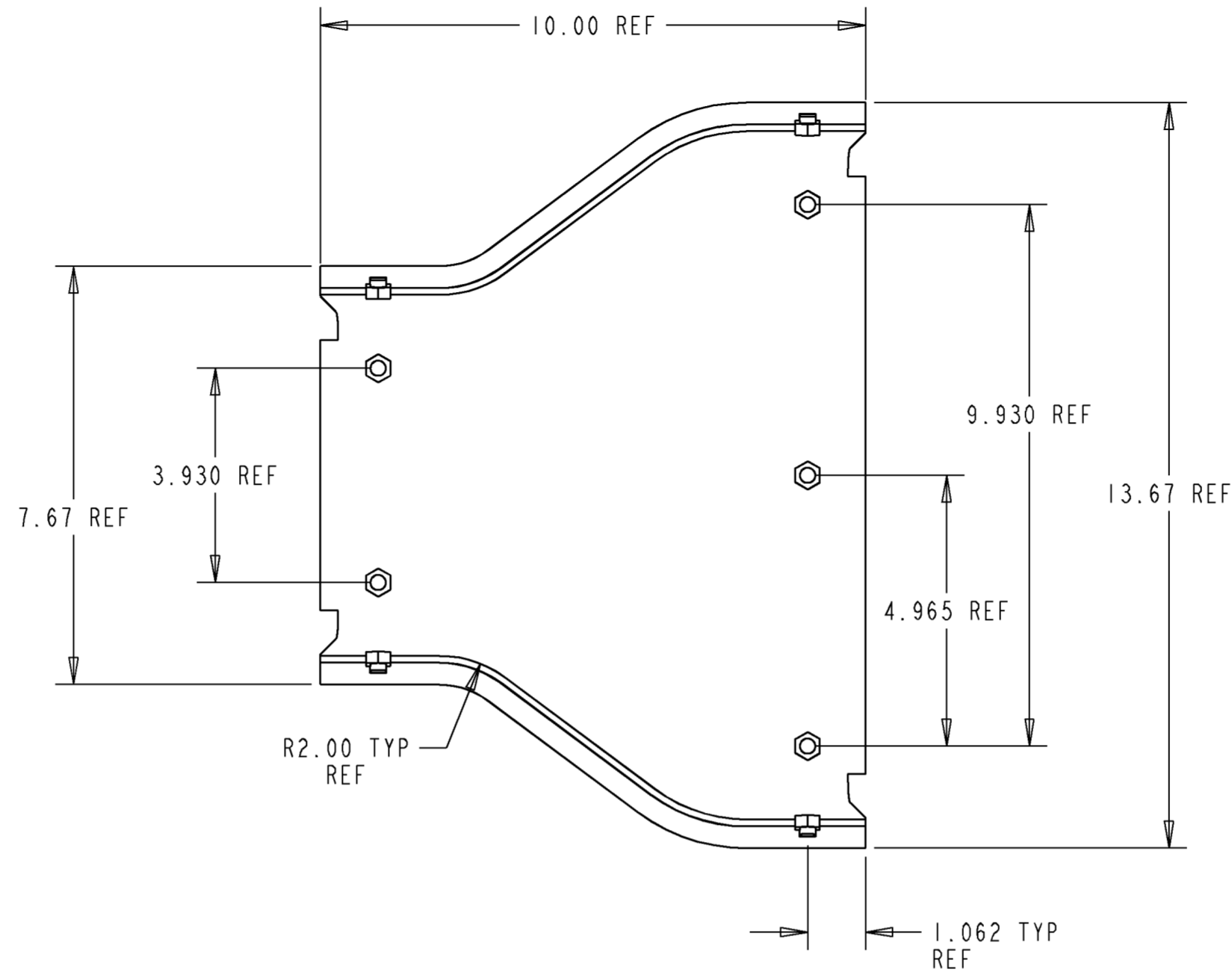
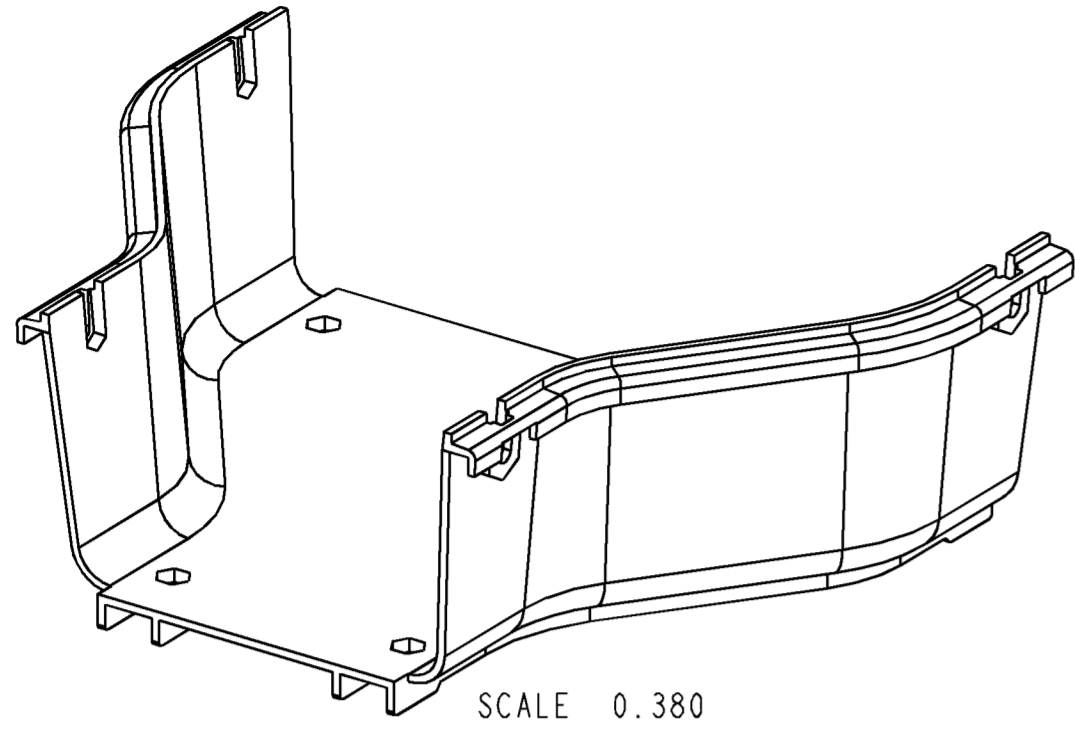

NOTES:

1. MATERIAL IS SELF EXTINGUISHING WITH A UL 94 RATING OF V-0.

CATALOG NO.	COLOR
FGSB-MDSA-FB	BLACK
FGS-MDSA-FB	YELLOW
FGSO-MDSA-FB	ORANGE



INFORMATION ON THIS DOCUMENT IS PROPRIETARY TO ADC AND SHALL NOT BE USED, COPIED, REPRODUCED OR DISCLOSED IN WHOLE OR IN PART WITHOUT WRITTEN CONSENT OF ADC.

TITLE ADAPTER, 12 TO 6, FGS

ALL DIMS AND TOLERANCES .XX:±.03 ARE INCHES UNLESS OTHERWISE SPECIFIED .XXX:±.020 ANGULAR:±1°

C SIZE DRAWING NUMBER 1044469 B REV

DO NOT SCALE DRAWING

ENGR: TIM HAATAJA  
DWN: TIM HAATAJA

SHT. 1 OF 1

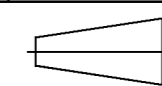
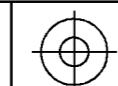

DIMENSIONS IN INCHES  
THIRD ANGLE PROJECTION