

# HST-BCANC1400NN000



## HST, NOVUX™ Prodigy™ Hardened Standard Terminal, 12-port, Armored cable, 1400 ft/426 m

- NOVUX™ Prodigy™ Hardened Multi-port Terminals incorporate Hardened connector technology that is designed to withstand the rugged outside plant environment
- Hardened connectors are factory-integrated and environmentally sealed for use in optical drop cable deployments
- Plug and play adapter ports ensure rapid cable installment in the outside plant access section of the network
- NOVUX™ Prodigy™ HST terminals are available with 2 to 12 ports and can be utilized in Single Fiber Point-to-Point (P2P) solutions
- Available with flat dielectric, flat toneable/locatable dielectric, armored or 5mm round cable
- NOVUX™ Prodigy™ smaller terminal size for aesthetics and allowing installation in constrained spaces
- NOVUX™ Prodigy™ terminals are available in Black (RAL# 9005) or Gray (RAL# 7035)
- CommScope Product ID plate with QR code link to product documents and C-Track

## Product Classification

<b>Regional Availability</b>	Asia   EMEA   Latin America   North America
<b>Product Type</b>	Access terminal, without splitter/tap
<b>Product Brand</b>	NOVUX™
<b>Product Series</b>	HST
<b>Minimum Order Quantity</b>	1

## General Specifications

<b>Cable Type</b>	Armored - Round - Loose Tube
<b>Cable, quantity</b>	1
<b>Distribution Type</b>	12 ports
<b>Drop Port Type</b>	Hardened Prodigy SC/APC
<b>Drop Port, quantity</b>	12
<b>Enclosure Color</b>	Black (RAL 9005)
<b>Mounting</b>	Handhole   Pedestal   Pole   Strand
<b>Port Type</b>	Hardened Prodigy SC/APC
<b>Port, quantity</b>	12
<b>Stub Type</b>	Stub tail

# HST-BCANC1400NN000

## Dimensions

<b>Height</b>	80 mm   3.15 in
<b>Width</b>	128 mm   5.039 in
<b>Length</b>	207 mm   8.15 in
<b>Cable Length, stub</b>	1400 ft (426 m)
<b>Cable Outer Diameter</b>	3.0 mm (0.12 in)

## Dimension Drawing

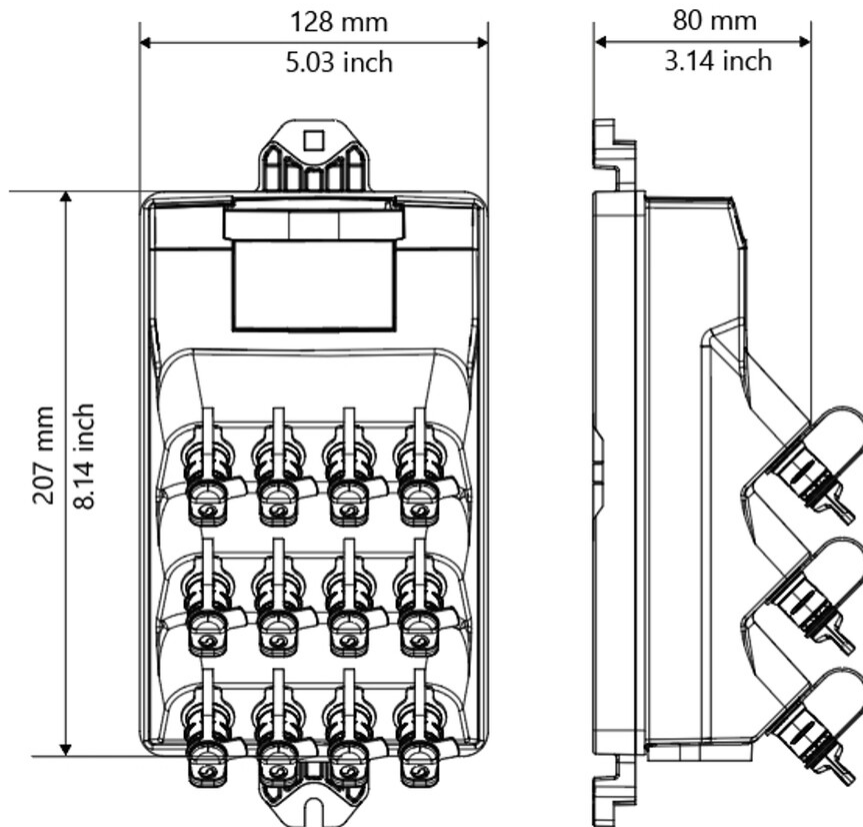

## Port Configuration

NOVUX HT	TECHNOLOGIES AVAILABLE	SMALL	MEDIUM	LARGE
HST Series	Single-fiber: P2P/no splitters	2 ports	6 ports	12 ports
		4 ports	8 ports	
	Single-fiber: P2P w/splitters	2 ports, 1x1:2	8 ports, 2x1:4	12 ports, 3x1:4
		4 ports, 1x1:4	8 ports, 1x1:8	
	Hybrid for multi-use		7 ports, 1x1:4 splitter, 3 P2P	12 ports, 1x1:8 splitter, 4 P2P
		4 ports, 1x1:2 splitter, 2 P2P	8 ports, 1x1:4 splitter, 4 P2P	11 ports, 2x1:4 splitter, 2 P2P, 1 HMFOC 4f

# HST-BCANC1400NN000

## Ordering Tree



## Material Specifications

**Enclosure Material Type** Hardened plastic

## Optical Specifications

**Fiber Type** G.657.A1/A2

**Operating Wavelength Range** 1260 – 1635 nm

**Attenuation Single Ports, maximum** 0.4 dB

**Attenuation Cable Coefficient, maximum** 0.30 dB/km @ 1550 nm | 0.40 dB/km @ 1310 nm

**Return Loss, Connector, typical** 65 dB

## Environmental Specifications

**Operating Temperature** -40 °C to +65 °C (-40 °F to +149 °F)

**Relative Humidity** 5%–100%, condensing

**Environmental Space** Above ground | Below ground

# HST-BCANC1400NN000

---

**Qualification Standards**

IEC 61753-1, category G | IEC 61753-111-08 (this represents an IEC 60529 IP68 intrusion protection level)

**UV Resistance**

UV stabilized

## Packaging and Weights

**Packaging quantity**

1

**Packaging Type**

Box | Universal spool, wood: terminal is on the top of the spool, stub deploys first

## Regulatory Compliance/Certifications

**Agency**

**Classification**

CHINA-ROHS

Below maximum concentration value

ISO 9001:2015

Designed, manufactured and/or distributed under this quality management system

REACH-SVHC

Compliant as per SVHC revision on [www.commscope.com/ProductCompliance](http://www.commscope.com/ProductCompliance)

ROHS

Compliant

UK-ROHS

Compliant

