

HST-B4ABA1500NU000



HST, NOVUX™ Prodigy™ Hardened Standard Terminal, 4-port Planar 1:4 Splitter, Dielectric flat loose tube cable, 1500 ft/457 m, Universal mounting bracket

- NOVUX™ Prodigy™ Hardened Multi-port Terminals incorporate Hardened connector technology that is designed to withstand the rugged outside plant environment
- Hardened connectors are factory-integrated and environmentally sealed for use in optical drop cable deployments
- Plug and play adapter ports ensure rapid cable installment in the outside plant access section of the network
- NOVUX™ Prodigy™ HST terminals are available with 2 to 12 ports and can be utilized in Single Fiber Point-to-Point (P2P) solutions
- Available with flat dielectric, flat toneable/locatable dielectric, armored or 5mm round cable
- NOVUX™ Prodigy™ smaller terminal size for aesthetics and allowing installation in constrained spaces
- NOVUX™ Prodigy™ terminals are available in Black (RAL# 9005) or Gray (RAL# 7035)
- CommScope Product ID plate with QR code link to product documents and C-Track
- *CommScope intends to release this product at a future date. At such time, this product will comply with the requirements of the Build America, Buy America Act and/or applicable waivers. Compliance requirements and waiver applicability vary based on government funding program. Check the laws and regulations for your specific program.
- *Product as currently available does not comply with the requirements of the Build America, Buy America Act. A new version under the same product number meeting the requirements listed above will be available at a future date.

Product Classification

Regional Availability	Asia EMEA Latin America North America
Product Type	Access terminal, with splitter/tap
Product Brand	NOVUX™
Product Series	HST
Government Funding	Build America Buy America (BABA) coming soon*
Minimum Order Quantity	1

General Specifications

Cable Type	Dielectric - Flat - Loose Tube
Cable, quantity	1
Distribution Type	1 x 4 splitter
Drop Port Type	Hardened Prodigy SC/APC
Drop Port, quantity	4

HST-B4ABA1500NU000

Enclosure Color	Black (RAL 9005)
Mounting	Handhole Pedestal Pole Strand
Port Type	Hardened Prodigy SC/APC
Port, quantity	4
Splitter, quantity	1
Stub Type	Stub tail

Dimensions

Height	80 mm 3.15 in
Width	79 mm 3.11 in
Length	161 mm 6.339 in
Cable Length, stub	1500 ft (457 m)
Cable Outer Diameter	4.3 x 8.0 mm (0.17 x 0.31 in)

Dimension Drawing

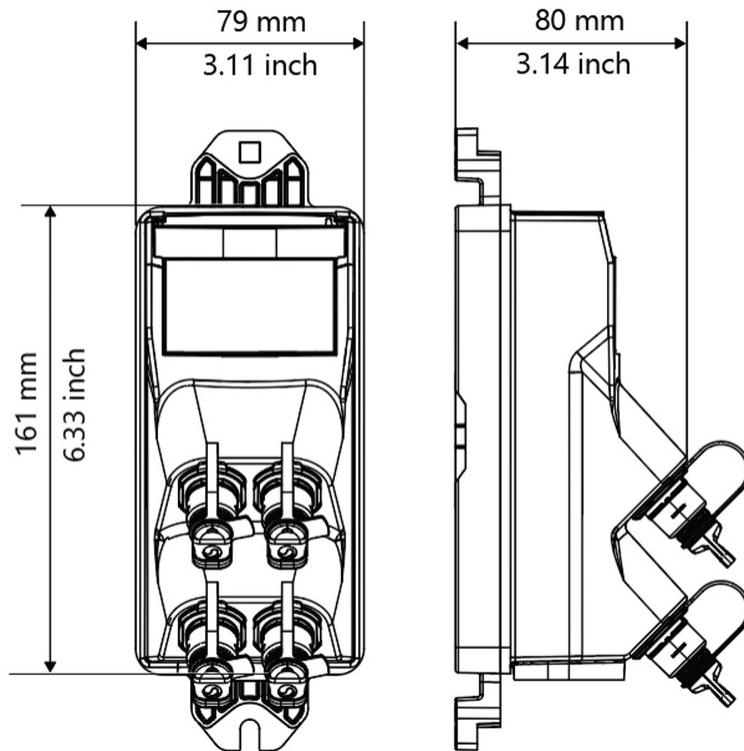

Port Configuration

HST-B4ABA1500NU000

NOVUX HT	TECHNOLOGIES AVAILABLE	SMALL	MEDIUM	LARGE	
HST Series	Single-fiber: P2P/no splitters	2 ports	6 ports	12 ports	
		4 ports	8 ports		
	Single-fiber: P2P w/splitters	2 ports, 1x1:2	8 ports, 2x1:4	12 ports, 3x1:4	
		4 ports, 1x1:4	8 ports, 1x1:8		
	Hybrid for multi-use			7 ports, 1x1:4 splitter, 3 P2P	12 ports, 1x1:8 splitter, 4 P2P
		4 ports, 1x1:2 splitter, 2 P2P	8 ports, 1x1:4 splitter, 4 P2P		11 ports, 2x1:4 splitter, 2 P2P, 1 HMFOC 4f

Ordering Tree



Material Specifications

Enclosure Material Type

Hardened plastic

Optical Specifications

Fiber Type

G.657.A1/A2

Operating Wavelength Range

1260 – 1635 nm

Attenuation Single Ports, maximum

7.5 dB

Attenuation Cable Coefficient, maximum

0.30 dB/km @ 1550 nm | 0.40 dB/km @ 1310 nm

Attenuation Splitter, maximum

7.1 dB

HST-B4ABA1500NU000

Attenuation Terminal Connectors, maximum	0.4 dB
Return Loss, Single Ports, minimum	55 dB

Environmental Specifications

Operating Temperature	-40 °C to +65 °C (-40 °F to +149 °F)
Relative Humidity	5%–100%, condensing
Environmental Space	Above ground Below ground
Qualification Standards	IEC 61753-1, category G IEC 61753-111-08 (this represents an IEC 60529 IP68 intrusion protection level)
UV Resistance	UV stabilized

Packaging and Weights

Included	Universal mounting bracket
Packaging quantity	1
Packaging Type	Box Universal spool, cardboard: terminal is on top of the spool, stub deploys first

Regulatory Compliance/Certifications

Agency	Classification
CHINA-ROHS	Below maximum concentration value
ISO 9001:2015	Designed, manufactured and/or distributed under this quality management system
REACH-SVHC	Compliant as per SVHC revision on www.commscope.com/ProductCompliance
ROHS	Compliant
UK-ROHS	Compliant

