

August, 2022

Notice of Universal bracket FTTx release

CommScope announces the release of the Universal bracket FTTx. MID :760253871

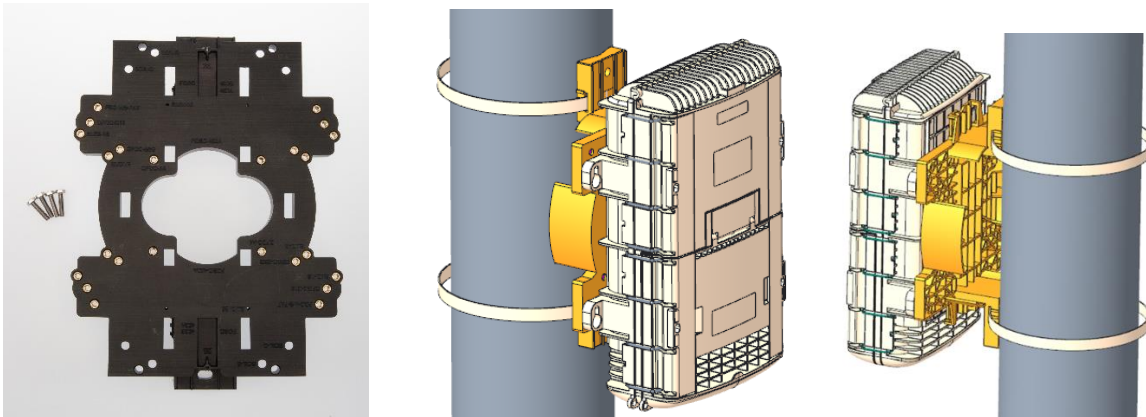

The new Universal bracket FTTx features:

- Robust nonmetallic design which can fit 12 different FTTx products
- 24 Stainless Steel inserts + 4 screws allow a fast and secure fixation of 7** products:
 - OFDC-A4/B8/B8G/C12**
 - FDC-W8-FAT**
 - BUDI-1S/BUDI-R**
 - BUDI-2S/SCIL-B/SCIL-C*

can use the fixation devices delivered within their kits*

- For **FOSC-400A/B**, metal or plastic hose clamps need to be ordered separately.
- Product names engraved in the bracket to identify screw placement.
- Integrated cable overlength storage
- Bracket can be Pole/Wall/Strand mounted.
 - Mounting devices are not part of the FTTx bracket kit.
- Bracket can replace the current metal bracket kits:
 - 760245338 | OFDC-C12-POLE-BRKT-KIT-US23
 - 760246227 | OFDC-C12-1 PIECE-POLE-BRKT
 - 760250986 | OFDC-C12-POLE/CABLE-BRKT

MOQ = 8 pcs (1box contains 8 brackets + 32 screws)

Pole Mounting

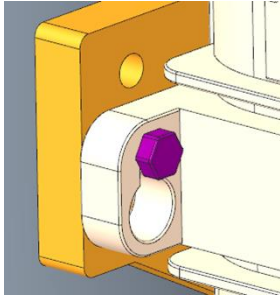

Mounting Screws

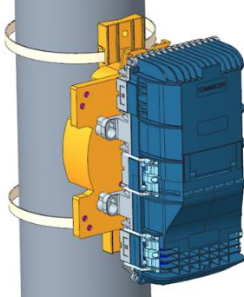

OFDC-B8G

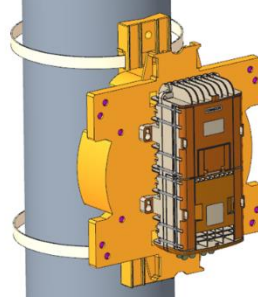

OFDC-A4

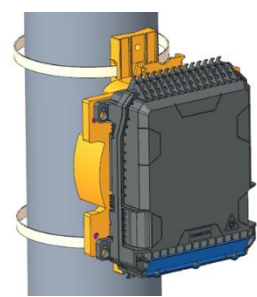

FDC-W8-FAT

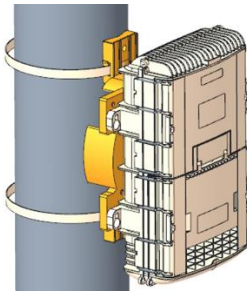

OFDC-C12

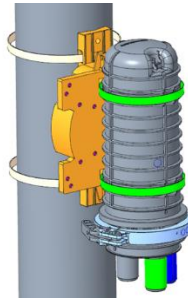

FOSC-400A4

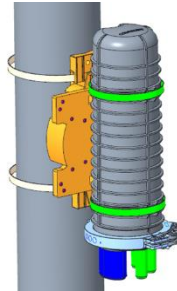

FOSC-400B4

Strand Mounting with the EM2200-001 | OFDC-C12-BRKSTRAND kit

