

HST-B7HGB0985NU000



HST, NOVUX™ Hardened Standard Terminal, 7-port, Planar 1:4 Splitter + three P2P, Flat toneable loose tube cable, 985 ft/300 m, Universal mounting bracket

- NOVUX™ Hardened Multi-fiber Terminals incorporate hardened connector technology that is designed to withstand the rugged outside plant environment
- Hardened connectors are factory-integrated and environmentally sealed for use in optical drop cable deployments
- Plug and play adapter ports ensure rapid cable installment in the outside plant access section of the network
- NOVUX™ HST terminals are available with 2 to 12 ports and can be utilized in Single Fiber Point-to-Point (P2P) solutions
- Available with flat dielectric, flat toneable/locatable dielectric, armored or 5mm round cable
- NOVUX™ smaller terminal size for aesthetics and allowing installation in constrained spaces
- NOVUX™ terminals are available in Black (RAL# 9005) or Gray (RAL# 7035)
- CommScope Product ID plate with QR code link to product documents and C-Track

Product Classification

Regional Availability	Asia EMEA Latin America North America
Product Type	Access terminal, with splitter/tap
Product Brand	NOVUX™
Product Series	HST
Minimum Order Quantity	1

General Specifications

Cable Type	Toneable - Flat - Loose Tube
Cable, quantity	1
Distribution Type	1 x 4 splitter + P2P ports (3)
Drop Port Type	Hardened full-size SC/APC
Drop Port, quantity	7
Enclosure Color	Black (RAL 9005)
Mounting	Handhole Pedestal Pole Strand
Port Type	Hardened full-size SC/APC
Port, quantity	7
Splitter, quantity	1
Stub Type	Stub tail

HST-B7HGB0985NU000

Dimensions

Height	80 mm 3.15 in
Width	157 mm 6.181 in
Length	192 mm 7.559 in
Cable Length, stub	985 ft (300 m)
Cable Outer Diameter	4.3 x 10.1 mm (0.17 x 0.40 in) in

Dimension Drawing

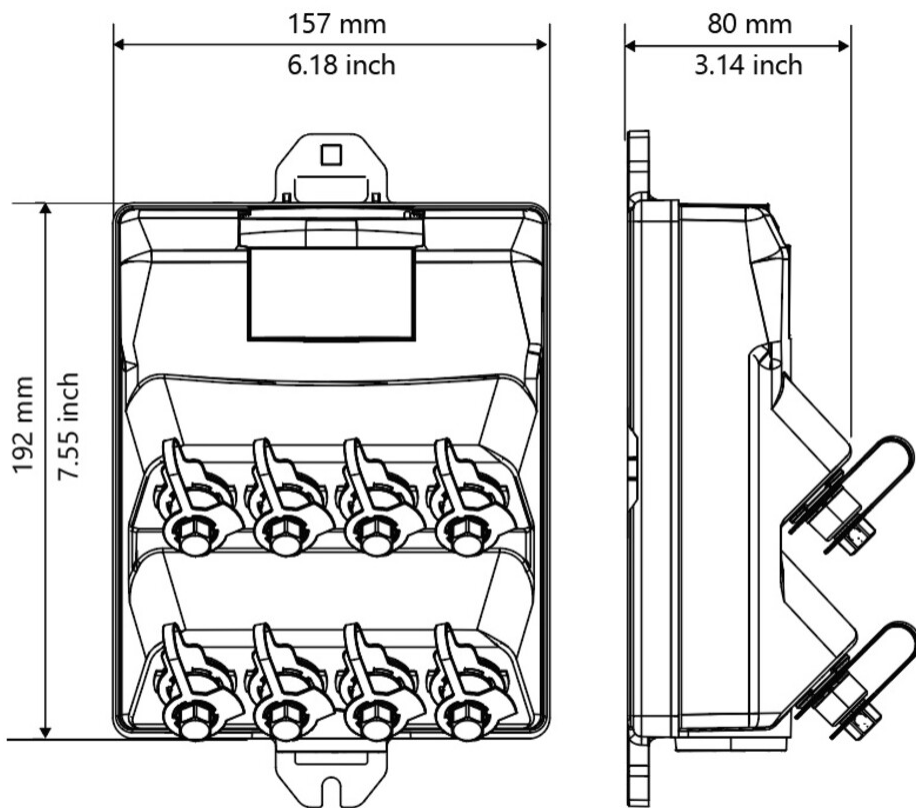

Port Configuration

HST-B7HGB0985NU000

NOVUX HT	TECHNOLOGIES AVAILABLE	SMALL	MEDIUM	LARGE	
HST Series	Single-fiber: P2P/no splitters	2 ports	6 ports	12 ports	
		4 ports	8 ports		
	Single-fiber: P2P w/splitters	2 ports, 1x1:2	8 ports, 2x1:4	12 ports, 3x1:4	
		4 ports, 1x1:4	8 ports, 1x1:8		
	Hybrid for multi-use			7 ports, 1x1:4 splitter, 3 P2P	12 ports, 1x1:8 splitter, 4 P2P
		4 ports, 1x1:2 splitter, 2 P2P	8 ports, 1x1:4 splitter, 4 P2P		11 ports, 2x1:4 splitter, 2 P2P, 1 HMFOC 4f

Ordering Tree



Material Specifications

Enclosure Material Type

Hardened plastic

Optical Specifications

Fiber Type

G.657.A1/A2

Operating Wavelength Range

1260 – 1635 nm

Attenuation Single Ports, maximum

7.5 dB

Attenuation Cable Coefficient, maximum

0.30 dB/km @ 1550 nm | 0.40 dB/km @ 1310 nm

Attenuation Splitter, maximum

7.1 dB

HST-B7HGB0985NU000

Attenuation Terminal Connectors, maximum	0.4 dB
Return Loss, Single Ports, minimum	55 dB

Environmental Specifications

Operating Temperature	-40 °C to +65 °C (-40 °F to +149 °F)
Relative Humidity	5%–100%, condensing
Environmental Space	Above ground Below ground
Qualification Standards	IEC 60529, IP68 + 2 m waterhead IEC 61753-1, category G
UV Resistance	UV stabilized

Packaging and Weights

Included	Universal mounting bracket
Packaging quantity	1
Packaging Type	Box Universal spool, cardboard: terminal is on top of the spool, stub deploys first

Regulatory Compliance/Certifications

Agency	Classification
CHINA-ROHS	Below maximum concentration value
ISO 9001:2015	Designed, manufactured and/or distributed under this quality management system
REACH-SVHC	Compliant as per SVHC revision on www.commscope.com/ProductCompliance
ROHS	Compliant
UK-ROHS	Compliant

