

COMMSCOPE®

mini Repeater

MR418 Single-Band



User's Manual
M0139AJH

DISCLAIMER:

This document has been developed by CommScope, and is intended for the use of its customers and customer support personnel. The information in this document is subject to change without notice. While every effort has been made to eliminate errors, CommScope disclaims liability for any difficulties arising from the interpretation of the information contained herein. The information contained herein does not claim to cover all details or variations in equipment, nor to provide for every possible incident to be met in connection with installation, operation, or maintenance. This document describes the performance of the product under the defined operational conditions and does not cover the performance under adverse or disturbed conditions. Should further information be desired, or should particular problems arise which are not covered sufficiently for the purchaser's purposes, contact CommScope.

CommScope reserves the right to change all hardware and software characteristics without notice.

COPYRIGHT:

© Copyright 2018 CommScope Inc. All Rights Reserved.

This document is protected by copyright. No part of this document may be reproduced, stored in a retrieval system, or transmitted, in any form or by any means, electronic, mechanical photocopying, recording, or otherwise without the prior written permission of CommScope.

TRADEMARKS

All trademarks identified by ® or ™ are registered trademarks or trademarks, respectively, of CommScope. Names of products mentioned herein are used for identification purposes only and may be trademarks and / or registered trademarks of their respective companies.

Andrew Wireless Systems GmbH, 28-February-2018

TABLE OF CONTENTS

1. GENERAL	6
1.1. ABBREVIATIONS	6
1.2. HEALTH AND SAFETY	7
1.3. PROPERTY DAMAGE WARNINGS	7
1.4. COMPLIANCE	8
1.5. ABOUT COMMSCOPE	9
1.6. INTERNATIONAL CONTACT ADDRESSES FOR CUSTOMER SUPPORT	10
2. INTRODUCTION	12
2.1. PURPOSE	12
2.2. THE MR418 REPEATER	12
3. FUNCTIONAL DESCRIPTION	14
3.1. GENERAL	14
3.2. DESIGN AND CONNECTORS	15
4. INSTALLATION AND COMMISSIONING	16
4.1. MECHANICAL INSTALLATION	16
4.1.1. Health and Safety for Mechanical Installation	16
4.1.2. Property Damage Warnings for Mechanical Installation	16
4.2. ELECTRICAL INSTALLATION	16
4.3. EXTERNAL-ALARM INPUTS AND SUMMARY-ALARM OUTPUT	20
4.3.1. External-Alarm Inputs	20
4.3.2. Summary-Alarm Output	22
5. SOFTWARE SETUP	23
5.1. LOGIN	23
5.2. MENU BAR – BUTTONS	24
5.3. STATUS BAR	24
5.4. STATUS	25

5.5.	SETTINGS	27
5.5.1.	Settings – Radio Frequency	28
5.5.2.	Settings – Alarms	30
5.5.3.	Settings – Modem Control	30
5.5.4.	Settings – LAN Connectivity	32
5.5.5.	Settings – User Account	34
5.6.	MAINTENANCE	35
5.7.	LOGOUT	36
5.8.	UPLOAD NEW SOFTWARE VERSION	37
6.	OPTIONAL EQUIPMENT	38
6.1.	EXTERNAL MODEM (KIT)	38
6.2.	INTEGRATED MODEM	38
6.3.	ANTENNA	39
6.4.	ADAPTER CABLE	39
7.	ALARMING AND SUPERVISION	40
7.1.	ALARM LEDS	40
7.2.	DISPLAY AND RESET & INSTALLATION ASSISTANCE BUTTON	41
7.3.	SNMP POLLING	43
7.3.1.	Requirements	43
7.3.2.	MIB Tree	43
7.3.3.	Examples	44
8.	APPENDIX	45
8.1.	ELECTRICAL SPECIFICATIONS	45
8.2.	ENVIRONMENTAL AND SAFETY SPECIFICATIONS	45
8.3.	MECHANICAL SPECIFICATIONS	46
8.4.	SPARE PARTS LIST	47
9.	INDEX	48
10.	LIST OF CHANGES	49

FIGURES AND TABLES

figure 3-1 Block diagram..... 14

figure 3-2 Connectors of MR418..... 15

figure 4-1 MR418, position of screws for wall mounting 16

figure 4-2 Power connection of DC connector with MR418 17

figure 4-3 External-alarm connector, inputs..... 20

figure 4-4 External-alarm inputs, PIN assignment & relay contacts 20

figure 4-5 External-alarm inputs, PIN assignment & potential-free relay contacts 21

figure 4-6 External-alarm inputs, PIN assignment & potential-free relay contacts 21

figure 4-7 Summary-alarm connector, PIN assignment..... 22

figure 4-8 Summary-alarm output, PIN assignment and relay contacts..... 22

figure 4-9 Summary-alarm output, PIN assignment for relay contacts..... 22

figure 5-1 Login page..... 23

figure 5-2 Status – General & Alarms, “RSSI Based Power OFF” set to “active”..... 25

figure 5-3 Status – General & Alarms, high-contrast page 25

figure 5-4 Settings – Radio Frequency, exemplary..... 28

figure 5-5 Settings – Alarms 30

figure 5-6 Settings – Modem Control 30

figure 5-7 Settings – LAN Connectivity 32

figure 5-8 Settings – User Account 34

figure 5-9 Maintenance..... 35

figure 5-10 Logout 36

figure 5-11 Upload new software version 37

figure 6-1 Position of modem connector 38

figure 6-2 SIM card opening and BTS connector..... 39

figure 6-3 Coverage antenna for MR418, optional equipment 39

figure 7-1 Display and alarm LEDs, exemplary..... 40

figure 7-2 Display with reset button and alarm LEDs , exemplary 41

figure 7-3 Display – RSSI 42

figure 7-4 Display – Gain UL and DL 42

figure 7-5 Display – P_{out} UL and DL..... 42

figure 8-1 Cabinet drawing MR418 46

table 4-1 External-alarm inputs, PIN assignment for relay contacts 20

table 4-2 External-alarm inputs, PIN assignment for potential-free relay contacts.... 21

table 4-3 External-alarm inputs, PIN assignment for potential-free relay contacts.... 21

table 5-1 Status bar, description 24

table 5-2 Status page 27

table 5-3 Settings - Modem Control 31

table 5-4 Settings – User Account page 34

table 5-5 Maintenance page, description..... 36

table 7-1 Alarm LEDs 41

1. General

1.1. Abbreviations

ALC	Automatic Level Control	OMC	Operation and Maintenance Center
AMPS	American Mobile Phone System or Advanced Mobile Phone System	PCMCIA	Personal Computer Modem Communication International Association
BCCH	Broadcast Control Channel	PCS	Personal Communication System
BITE	Built-In Test Equipment	PSTN	Public Switched Telephone Network
BTS	Base Transceiver Station	RED	Radio Equipment Directive Revision
CEPT	Conférence Européenne des Postes et Télécommunications	RF	Radio Frequency
CF	Center Frequency	RLP	Radio Link Protocol
CFO	Center Frequency Offset	RSSI	Receive Signal Strength Indication
CFR	Code of Federal Regulations	RTC	Real-Time Clock
DL	Downlink	RX	Receiver
DoC	Declaration of Conformity	RoHS	Directive on Restriction of certain Hazardous Substances
EDGE	Enhanced Data Rates for GSM Evolution	RSSI	Receive Signal Strength Indication
ESD	Electrostatic Discharge	RTC	Real-Time Clock
ETACS	Enhanced TACS	RX	Receiver
ETS	European Telecommunication Standard	SCL	Serial Clock
ETSI	European Telecommunication Standards Institute	SDA	Serial Data
FSK	Frequency Shift Keying	TACS	Total Access Communication System
GSM	Global System for Mobile Communication	TCH	Traffic Channel
GUI	Graphical User Interface	TDMA	Time Division Multiple Access
I2C-Bus	Inter-Integrated Circuit Bus (Philips)	TX	Transmitter
ID No	Identification Number	UL	Uplink
IF	Intermediate Frequency	UMTS	Universal Mobile Telecommunications System
MCC	Mobile Country Code	UPS	Uninterruptable Power Supply
MNC	Mobile Network Code		
MR	Microwave Repeater		
MS	Mobile Station		
MTBF	Mean Time Between Failure		

1.2. Health and Safety



Caution: High frequency radiation in operation. Risk of health hazards associated with radiation from the antenna(s) connected to the unit. Implement prevention measures to avoid the possibility of very close proximity to the antenna(s) while in operation.

1.3. Property Damage Warnings

1. **Notice:** Although the repeater is internally protected against overvoltage, it is strongly recommended to ground (earth) the antenna cables close to the repeater's antenna connectors for protection against atmospheric discharge.



2. **Notice:** ESD precautions must be observed. Before commencing maintenance work, use the available grounding (earthing) system to connect ESD protection measures.

3. **Notice:** Only suitably qualified personnel are allowed to work on this unit and only after becoming familiar with all safety notices, installation, operation and maintenance procedures contained in this manual.

4. **Notice:** Keep operating instructions within easy reach and make them available to all users.

5. **Notice:** Read and obey all the warning labels attached to the unit. Make sure that all warning labels are kept in a legible condition. Replace any missing or damaged labels.

6. **Notice:** Only license holders for the respective frequency range are allowed to operate this unit.

7. **Notice:** Make sure the repeater settings are correct for the intended use (refer to the manufacturer product information) and regulatory requirements are met. Do not carry out any modifications or fit any spare parts, which are not sold or recommended by the manufacturer.

1.4. Compliance

1. **Notice:** For installations which have to comply with European EN50385 exposure compliance requirements, the following Power Density limits/guidelines (mW/cm²) according to ICNIRP are valid:
 - 0.2 for frequencies from 10 MHz to 400 MHz
 - $F \text{ (MHz)} / 2000$ for frequencies from 400 MHz to 2 GHz
 - 1 for frequencies from 2 GHz to 300 GHz
2. **Notice:** Installation of this equipment is in full responsibility of the installer, who has also the responsibility, that cables and couplers are calculated into the maximum gain of the antennas, so that this value, which is filed in the FCC Grant and can be requested from the FCC data base, is not exceeded. The industrial boosters are shipped only as a naked booster without any installation devices or antennas as it needs for professional installation.
3. **Notice:** Corresponding local particularities and regulations must be observed. For national deviations, please refer to the respective documents that can be downloaded as well.
4. **Notice:** The power supply of the unit complies with Overvoltage Category II. It also complies with the surge requirement according to EN 61000-4-5 (fine protection); however, installation of an additional medium (via local supply connection) and/or coarse protection (external surge protection) is recommended depending on the individual application in order to avoid damage caused by overcurrent.
5. **Note:** This unit complies with European standard EN60950-1 / EN62368-1.

Equipment Symbols Used / Compliance

Please observe the meanings of the following symbols used in our equipment and the compliance warnings:

Symbol	Compliance	Meaning / Warning
CE	CE	To be sold exclusively to mobile operators or authorized installers – no harmonized frequency bands, operation requires license. Intended use: EU and EFTA countries
		Indicates conformity with the RED directive 2014/53/EU and/or RoHS directive 2011/65/EU.
CE 0700	CE	Indicates conformity with the RED directive 2014/53/EU and RoHS directive 2011/65/EU certified by the notified body no. 0700.

1.5. About CommScope

CommScope is the foremost supplier of one-stop, end-to-end radio frequency (RF) solutions. Part of the *CommScope* portfolio are complete solutions for wireless infrastructure from top-of-the-tower base station antennas to cable systems and cabinets, RF site solutions, signal distribution, and network optimization. For patents see www.cs-pat.com.

CommScope has global engineering and manufacturing facilities. In addition, it maintains field engineering offices throughout the world.

Andrew Wireless Systems GmbH based in Buchdorf/Germany, which is part of *CommScope*, is a leading manufacturer of coverage equipment for mobile radio networks, specializing in high performance, RF and optical repeaters. Our optical distributed networks and RF repeater systems provide coverage and capacity solution for wireless networks in both indoor installations and outdoor environments, e.g. tunnels, subways, in-trains, airport buildings, stadiums, skyscrapers, shopping malls, hotels and conference rooms.

Andrew Wireless Systems GmbH operates a quality management system in compliance with the requirements of ISO 9001 and TL 9000. All equipment is manufactured using highly reliable material. To maintain highest quality of the products, comprehensive quality monitoring is conducted at all fabrication stages. Finished products leave the factory only after a thorough final acceptance test, accompanied by a test certificate guaranteeing optimal operation.

Hereby Andrew Wireless Systems declares that the radio equipment type Repeater is in compliance with Directive 2014/53/EU.

The full text of the EU declaration is available at the following internet address: www.commscope.com/collateral/Declarations_of_Conformity/.

According to the DoC, our “CE”-marked equipment can be used in all member states of the European Union.

Note: Exceptions of and national deviations from this intended use may be possible. To observe corresponding local particularities and regulations, please refer to the respective documents (also in national language) which can be downloaded as well.

To make the most of this product, we recommend you carefully read the instructions in this manual and commission the system only according to these instructions.

For technical assistance and support, please also contact the local office or *CommScope* directly at one of the addresses listed in the following chapter.

1.6. International Contact Addresses for Customer Support

Canada		United States
CommScope Canada		Andrew LLC, A CommScope Company
Mail 505 Consumers Road, Suite 803 Toronto M2J 4V8, Canada		Mail 620 North Greenfield Parkway Garner, NC 27529, U.S.A.
Phone +1-905-878-3457 (Office) +1-416-721-5058 (Cell)	A M E R I C A S	Phone +1-888-297-6433
Fax +1-905-878-3297		Fax +1-919-329-8950
E-mail wisupport@commscope.com		E-mail wisupport@commscope.com
Caribbean & South American Region		Caribbean & Central American Region
CommScope Cabos do Brasil Ltda.		CommScope Mexico S.A. de C.V.
Mail CALA Tech Support for <i>Distributed Coverage & Capacity Solutions (DCCS) products:</i> Rua Guaporanga, 49 Praça Seca – Rio de Janeiro – RJ ZIP: 21320-180, Brazil		Mail CALA Tech Support for <i>Distributed Coverage & Capacity Solutions (DCCS) products:</i> Av. Insurgentes Sur 688, Piso 6 Col. Del Valle, CP: 03100 Mexico City, Mexico
Phone +1-815-546-7154 (Cell) +55-15-9104-7722 (Office)		Phone +52-55-1346-1900 (Office)
Fax + 55-15-2102-4001		Fax +52-55-1346-1901
E-mail wisupport@commscope.com		E-mail wisupport@commscope.com
China, India and Rest of Asia		Australia & New Zealand
Andrew International Corporation		Andrew Corporation (Australia) Pty Ltd.
Mail Room 915, 9/F Chevalier Commercial Centre 8 Wang Hoi Rd Kowloon Bay, Hong Kong	A P A C	Mail Unit 1 153 Barry Road Campbellfield VIC 3061, Australia
Phone +852-3106-6100		Phone +613-9300-7969
Fax +852-2751-7800		Fax +613-9357-9110
E-mail wisupport.China@commscope.com		E-mail wisupport.Australia@commscope.com
Middle East & North Africa		South Africa
CommScope Solutions International Inc. (Branch)		Andrew Wireless Solutions Africa (PTY) LTD
Mail PO Box 48 78 22 Unit 3206, Floor 32, Jumeirah Business Center 5, Jumeirah Lakes Towers, Dubai, United Arab Emirates	A f r i c a & M i d d l e E a s t	Mail 11 Commerce Crescent West Eastgate, Sandton PO Box 786117 Sandton 2146 South Africa
Phone +971 4 390 09 80		Phone + 27 11-719-6000
Fax +971 4 390 86 23		Fax + 27 11-444-5393
E-mail wisupport@commscope.com		E-mail wisupport@commscope.com

United Kingdom		Scandinavia	
Andrew Wireless Systems UK Ltd Unit 15, Ilex Building Mulberry Business Park Fishponds Road Wokingham Berkshire RG41 2GY, England Phone +44-1189-366-792 Fax +44-1189-366-773 E-mail wisupport.uk@commscope.com		Andrew Norway (AMNW) P.O. Box 3066 Osloveien 10 Hoenefoss 3501 Norway Phone + 47 32-12-3530 Fax + 47 32-12-3531 E-mail wisupport@commscope.com	
Germany		France	
Andrew Wireless Systems GmbH Industriering 10 86675 Buchdorf Germany Phone +49-9099-69-0 Fax +49-9099-69-930 E-mail wisupport@commscope.com		CommScope France Immeuble Le Lavoisier 4, Place des Vosges 92052 Courbevoie, France Phone +33-1 82 97 04 00 Fax +33-1 47 89 45 25 E-mail wisupport@commscope.com	
Austria		Switzerland	
Andrew Wireless Systems (Austria) GmbH Weglgasse 10 2320 Wien-Schwechat Austria Phone +43-1706-39-99-10 Fax +43-1706-39-99-9 E-mail wisupport.austria@commscope.com		CommScope Wireless Systems AG Tiergartenweg 1 CH-4710 Balsthal Switzerland Phone +41-62-386-1260 Fax +41-62-386-1261 E-mail wisupport.ch@commscope.com	
Italy		Iberia Region – Spain & Portugal	
CommScope Italy S.r.l., Faenza, Italy Via Mengolina, 20 48018 Faenza (RA) Italy Phone +39-0546-697111 Fax +39-0546-682768 E-mail wisupport.italia@commscope.com		Andrew España S.A. A CommScope Company Avda. de Europa, 4 – 2ª pta. Parque Empresarial de la Moraleja Alcobendas, Madrid 28108, Spain Phone +34-91-745-20 40 Fax +34-91-661-87 02 E-mail wisupport.iberia@commscope.com	
Czech Republic			
CommScope Solutions Czech Republic C-Com, spol. s r.o U Moruší 888 53006 Pardubice, Czech Republic Phone +49 871 9659171 (Office) +49 171 4001166 (Mobile) Fax +49 871 9659172 E-mail wisupport@commscope.com			

EUROPE

2. Introduction

2.1. Purpose

The MR418 is a bi-directional amplifier used to enhance signals between a mobile and a base station in a mobile network. It has been designed to increase signal strength in small and medium sized areas such as offices, shops, and basements. By boosting the signal level the MR418 increases indoor coverage and allows high data rate connectivity.

If weak signal transmissions occur within the coverage area due to indoor applications, topological conditions or distance from the transmitter, a repeater is used to extend transmission range. In the downlink path, the repeater picks up the signals from a donor antenna of a BTS, amplifies and re-transmits it into the required dark spot. In the uplink path the repeater picks up the signals from a mobile and re-transmits it to the BTS.

2.2. The MR418 Repeater

The MR418 repeater is a cost effective solution for enhancing indoor coverage for 400 MHz TETRA and Tetrapol applications. The MR418 gives designers a simple tool to solve their small area 400 MHz TETRA and Tetrapol coverage and performance issues.

Especially public safety services demand reliable coverage even in indoor areas. By increasing the signal level the MR418 improves voice quality and allows high data rate connectivity.

A web-based GUI (Graphical User Interface) simplifies to commission and configure the equipment. The RF link (donor) towards the base station is typically fed from an outdoor antenna while the coverage area is fed by an indoor antenna.

Auto Gain functionality enables automatic gain adjustment in order to maximize the performance in changing RF environments; however, gain may be set manually if desired. An alarm interface with LED's and display indicates the status of the equipment locally. Moreover the status and alarms of the MR418 can be queried in the web-based GUI.

Optionally, a GSM modem is offered for monitoring the MR418 via SMS. I.e. a SMS is sent to the common Andrew OMC or to a standard SMS receiver (even a mobile phone) and any settings of the MR418 can be changed by a SMS launched from the OMC or mobile. A heartbeat SMS notifies whether the system is in operation.

Moreover, the MR418 can be connected to LAN.

Features:

- Easy to install due to light weight, small dimensions and Auto Gain functionality
- Easy commissioning via web-based GUI
- Automatic level control (ALC)
- LEDs for local alarm indication
- RSSI and Status indication via display
- Meeting ETSI TS 101 789-1
- Optional remote control via SMS
- Optional with or w/o integrated GSM modem
- Upgrade with external GSM modem possible
- Connection to LAN
- Remote alarming via SNMP alarm traps
- 2 external-alarm inputs
- Summary alarm relays contact

3. Functional Description

3.1. General

The MR418 amplifies a 5 MHz band occupied in the 400 MHz band. The operation principle is depicted in the following block diagram:

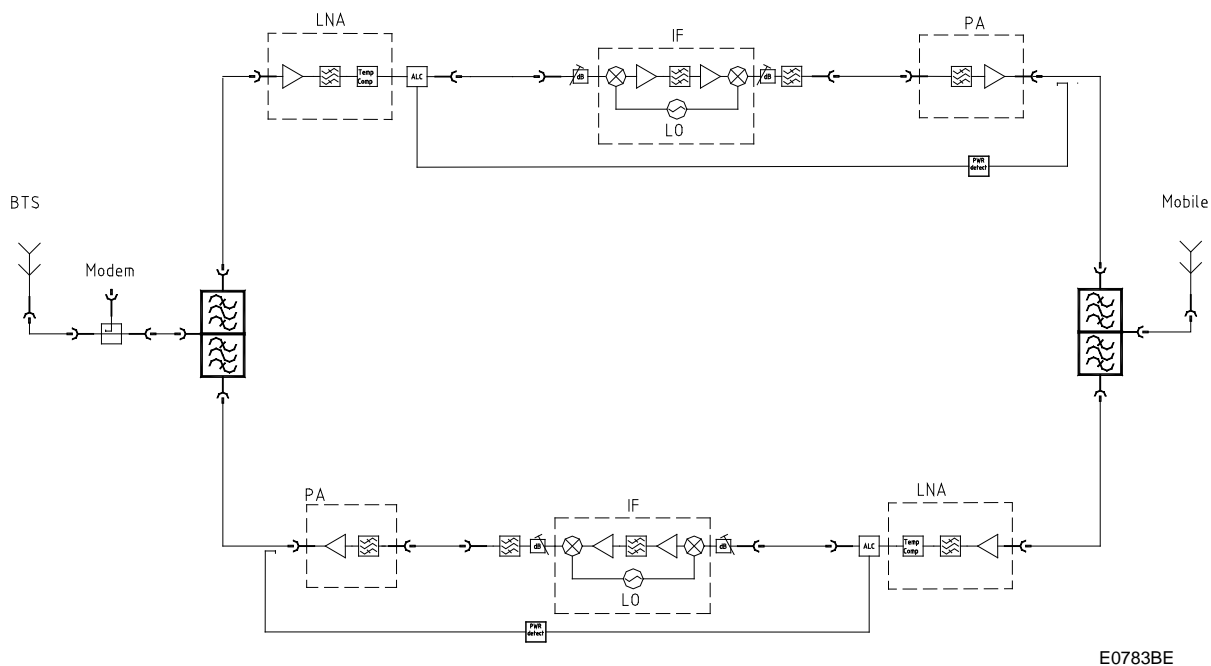
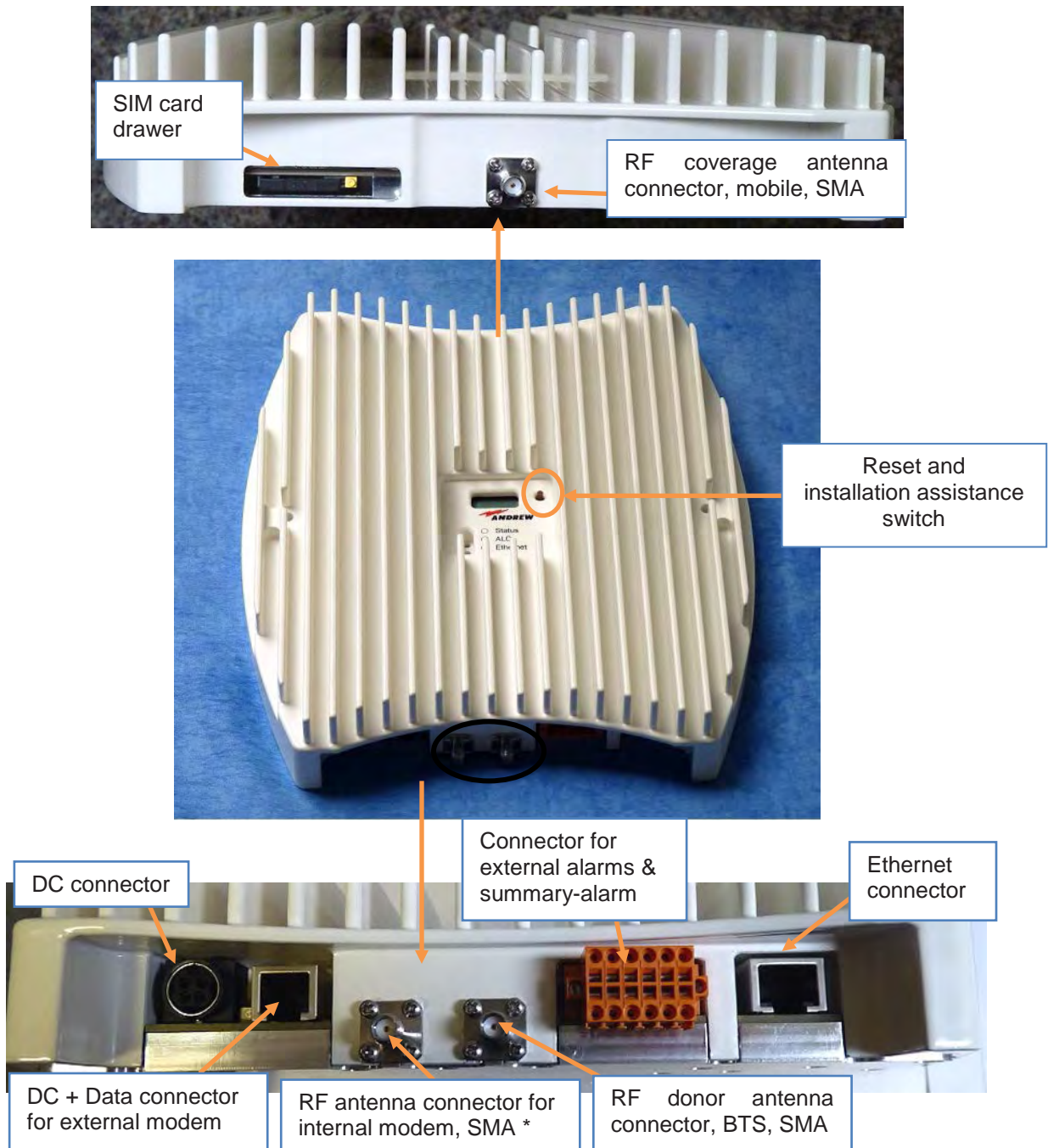

figure 3-1 Block diagram

3.2. Design and Connectors



* will not be equipped for units *without* internal modem in future

figure 3-2 Connectors of MR418

Note: SMA connectors have a specified torque of 0.45 N-m. Use an appropriate tool to fasten and unfasten these connectors. Do not over-tighten the connectors or screws.

4. Installation and Commissioning

4.1. Mechanical Installation

4.1.1. Health and Safety for Mechanical Installation



1. **Caution:** Risk of serious personal injury by equipment falling due to improper installation. The installer must verify that the supporting surface will safely support the combined load of the electronic equipment and all attached hardware and components. The screws and dowels (wall anchors) used should also be appropriate for the structure of the supporting wall.

4.1.2. Property Damage Warnings for Mechanical Installation

1. **Attention:** Do not install the unit in a way or at a place where the specifications outlined in the Environmental and Safety Specifications leaflet of the supplier are not met.
2. **Attention:** It is the responsibility of the installer to verify that the supporting surface will safely support the combined load of the electronic equipment and all attached hardware and components and to ensure that the unit is safely and securely mounted.
3. **Notice:** Use proper mounting hardware depending on the structure of e.g. the wall where the unit will be installed.

Mount the MR418 to a wall with two screws (spacers not required).

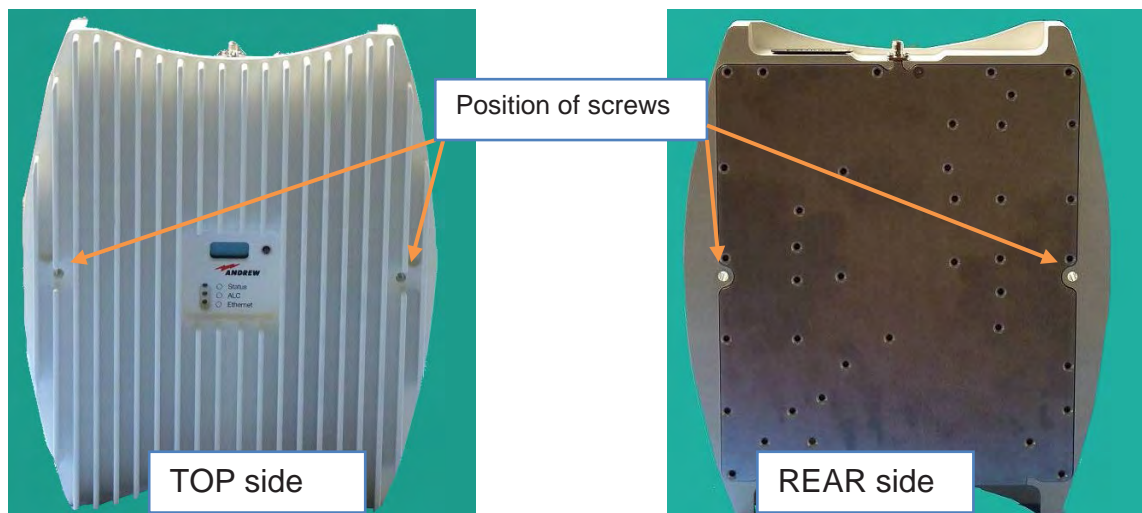

figure 4-1 MR418, position of screws for wall mounting

4.2. Electrical Installation

1. **Notice:** The electrical installation has to be performed in accordance with the safety regulations of the local authorities. Due to safety reasons, the electrical installation must be performed by qualified personnel only. The repeater must not be opened.
2. **Notice:** Observe the labels on the front panels before connecting or disconnecting any cables.

- Connect the antenna cables to the antenna connectors and the antennas.
- Use only the power supply delivered with the unit. Do not modify the power supply unit (PSU) and cable.

Do not mount the PSU to the ceiling.

Connect the DC connector of the power supply and provide mains to the power supply. Ensure the DC connector is plugged in correctly as in the following illustrations.

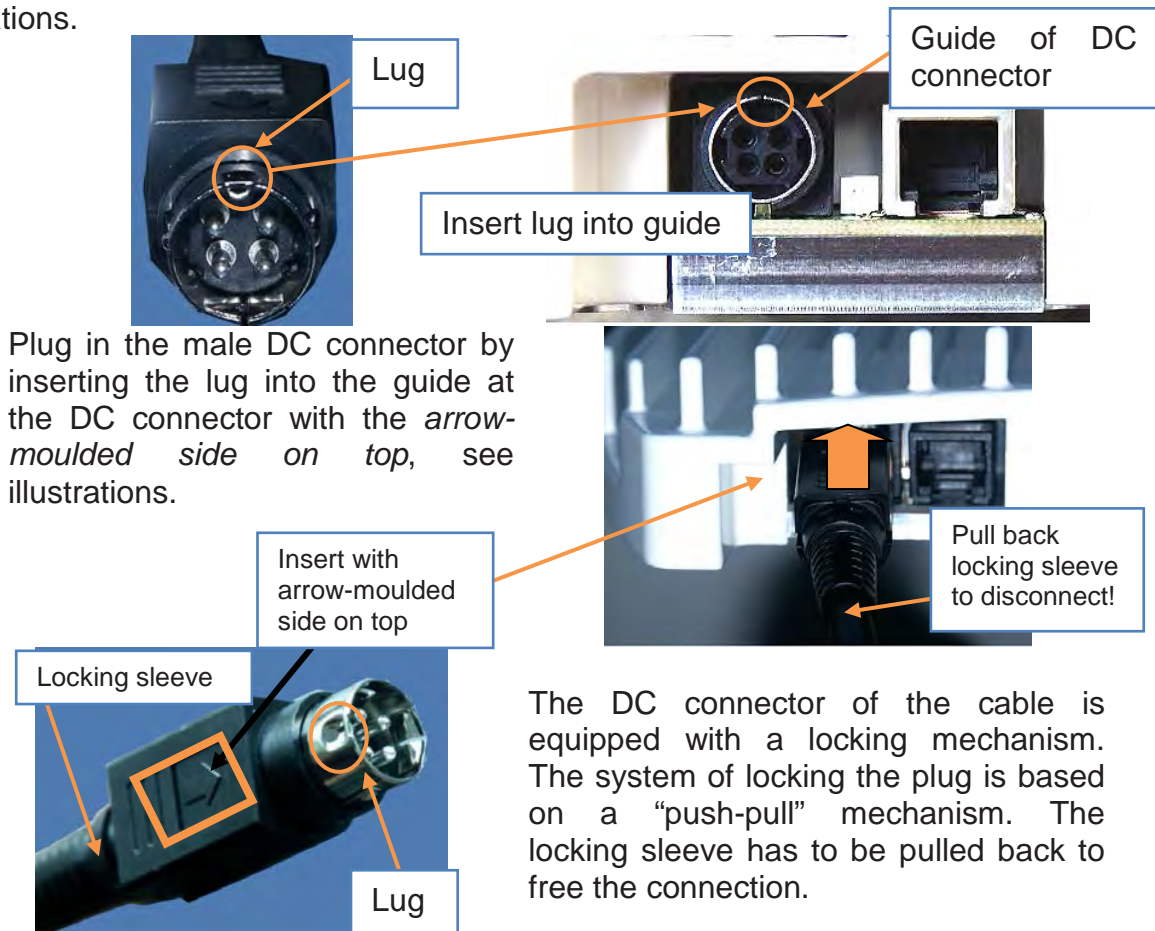

figure 4-2 Power connection of DC connector with MR418

- Align the donor antenna towards the BTS. The MR418 provides antenna alignment assistance. Therefore, press the “Reset and installation assistance” switch (see chapter 3.2 *Design and Connectors*) for at least *four seconds* **after** (!) the boot process has been finished (i.e. red ALC LED is blinking for four seconds). This will set the gain to max. value and disable Auto Gain for about four minutes. The status LED will be blinking red/green. Align the donor antenna towards the BTS tower to reach the highest RSSI level possible. Check the RSSI level at the display (see chapter 7 *Alarming and Supervision*). After four minutes, the gain and Auto Gain are adjusted to the same values prior to the activation of the antenna alignment.
- Align the coverage antenna.

As the default settings of the repeater are set to 'Auto Gain enabled', only the frequencies have to be adjusted. Additionally, the repeater can be customized with a laptop or PC via Ethernet connector:

- For local connection, connect the **straight** CAT 6 patch cable to the Ethernet connector of the MR418 and the network connector of a laptop or PC. For MR418 connection to a LAN network connect the **cross-over** cable. (Note: The MR418 operates at 10 Mbps and full-duplex).
- Start a browser (e.g. Internet Explorer recommended versions 10 or 11, or Mozilla Firefox, recommended versions 29 up to 35) and enter URL: **http://192.168.1.1**. For IE10/IE11 make sure the "Browser Mode" is set to Compatibility View as explained at the end of this chapter.

Note: If the connection cannot be established, it might be necessary to set the IP address of the computer or laptop (Start => Settings => Control Panel => Network Connections => *Your Network-Connection* => Properties => Internet Protocol (TCP/IP) => Properties => Enable 'Use the following IP address' and enter an IP address, e.g. 192.168.1.10). **Do not use IP addresses 192.168.1.2 or 192.168.1.1!**

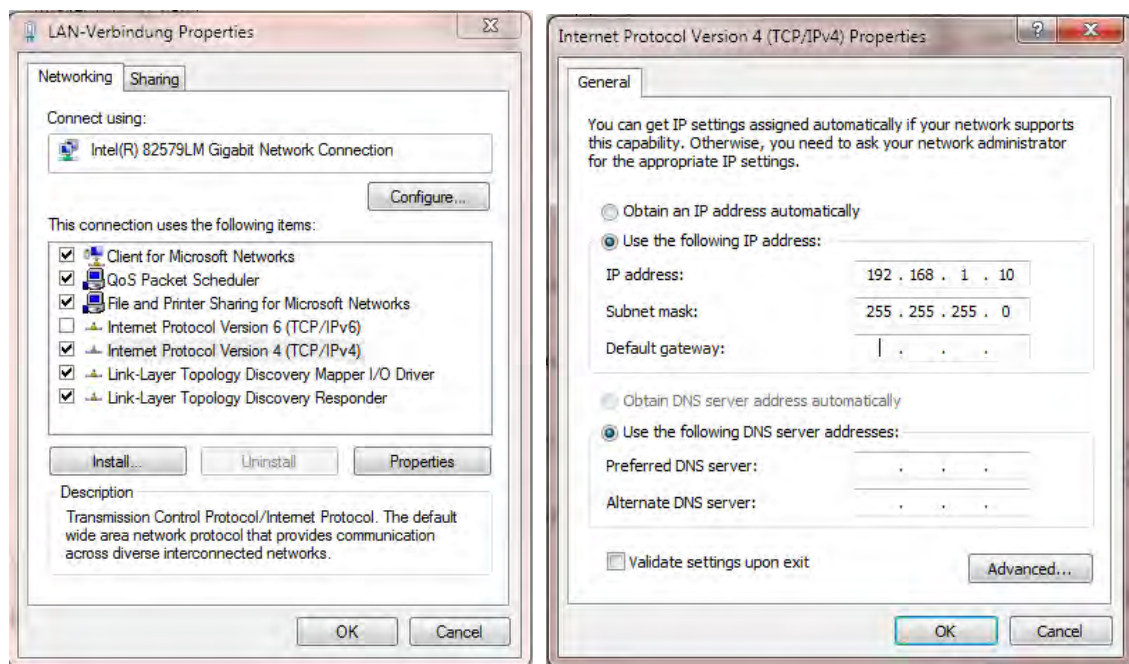

Before changing the settings in the Internet Protocol (TCP/IP) => Properties, please write down the current settings. Ensure no proxy server for internet access is activated any longer, either.

STOP

After having finished setting up the MR418, please change all the TCP/IP settings to the original ones **BEFORE** re-connecting your computer to any other network. Re-activate the proxy settings if necessary, too.

- Enter User name: **MRx18** and password: **MRx18** (case-sensitive).
- Commission the repeater according to the description in the following chapter and save settings to the repeater.
- Disconnect the CAT 6 patch cable and check LEDs and display of the repeater.

In case the Ethernet connection cannot be established due to wrong settings in the Connectivity page (see chapter 5.5.4 *Settings – LAN Connectivity*) or if username or password have been forgotten, these settings can be reset to the default factory settings.

To reset Ethernet settings, username and password to the default factory settings, press the “Reset and installation assistance switch” during the boot process (i.e. red ALC LED is blinking for four seconds after power has been supplied) and keep the switch pressed until the boot process starts again (Ethernet LED starts blinking). It is not possible to execute a reset when a local connection is established.

Browser mode settings:

In IE10, just click „Compatibility View“:

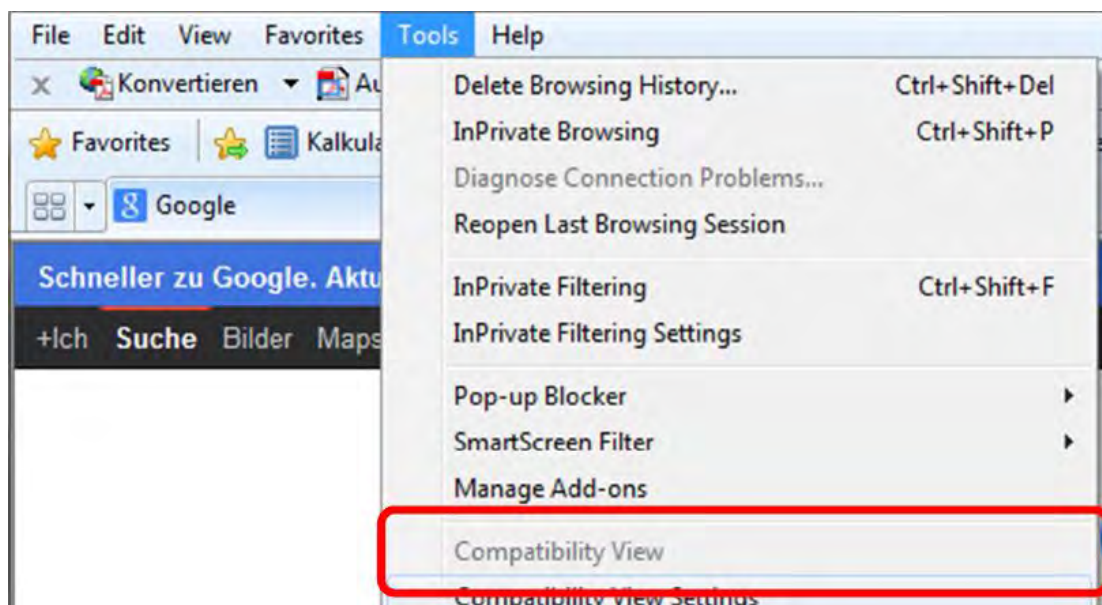

In IE11, open the „Compatibility View Settings“ and mark all checkboxes:

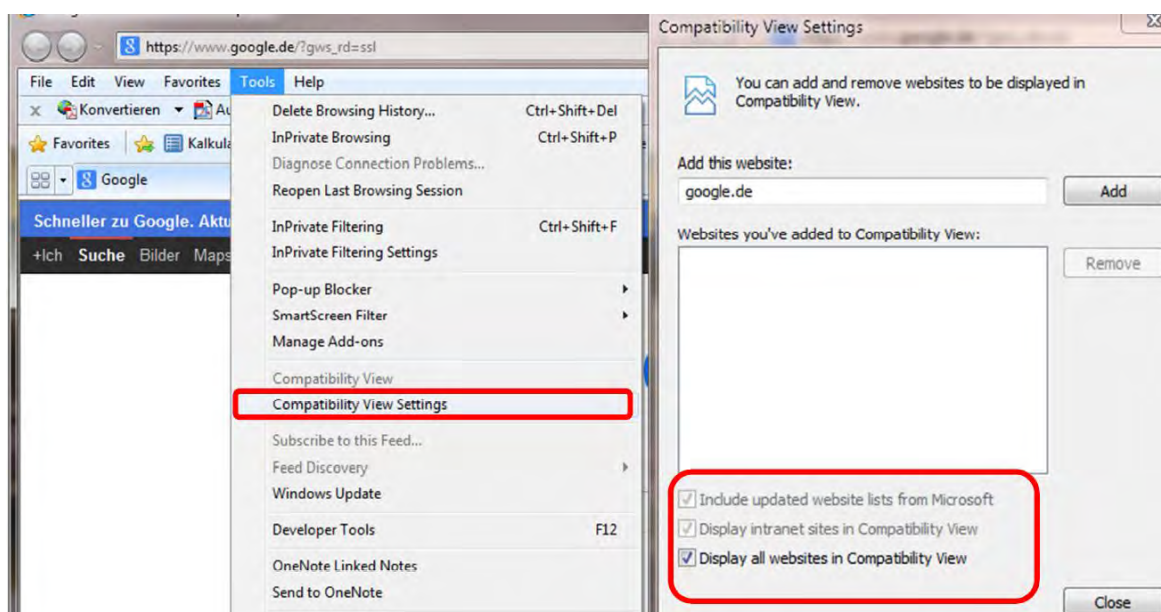

4.3. External-Alarm Inputs and Summary-Alarm Output

4.3.1. External-Alarm Inputs

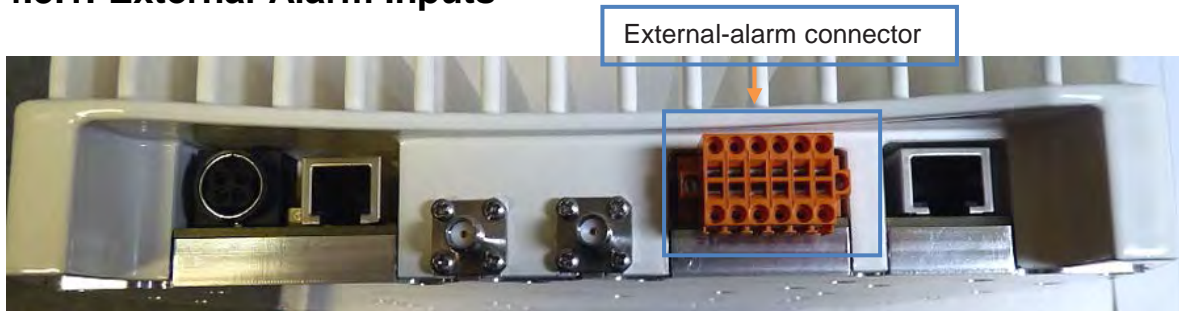

figure 4-3 External-alarm connector, inputs

Two external-alarm inputs are provided to monitor the status of external devices.

The external alarms are locally indicated via the web-based GUI or the display. The alarms can be forwarded to A.I.M.O.S. or to an SMS receiver via modem.

Opto-coupled inputs monitor external devices providing 0 to 5 Vdc. Depending on the logic of the alarm (active low / active high) an external alarm is generated at low or high level. In case an external device shall be captured via an alarm-relay contact, 5 V and GND need to be linked by a wire jumper to the corresponding PINs.

External-Alarm Inputs - Relay Contacts

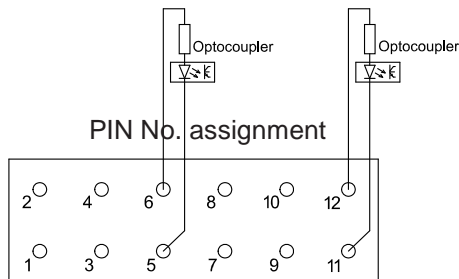

figure 4-4 External-alarm inputs, PIN assignment & relay contacts

External-Alarm Inputs		
	+	-
Ext. Alarm 1	PIN 6	PIN 5
Ext. Alarm 2	PIN 12	PIN 11

table 4-1 External-alarm inputs, PIN assignment for relay contacts

External-Alarm Inputs (monitoring potential free relay contact)

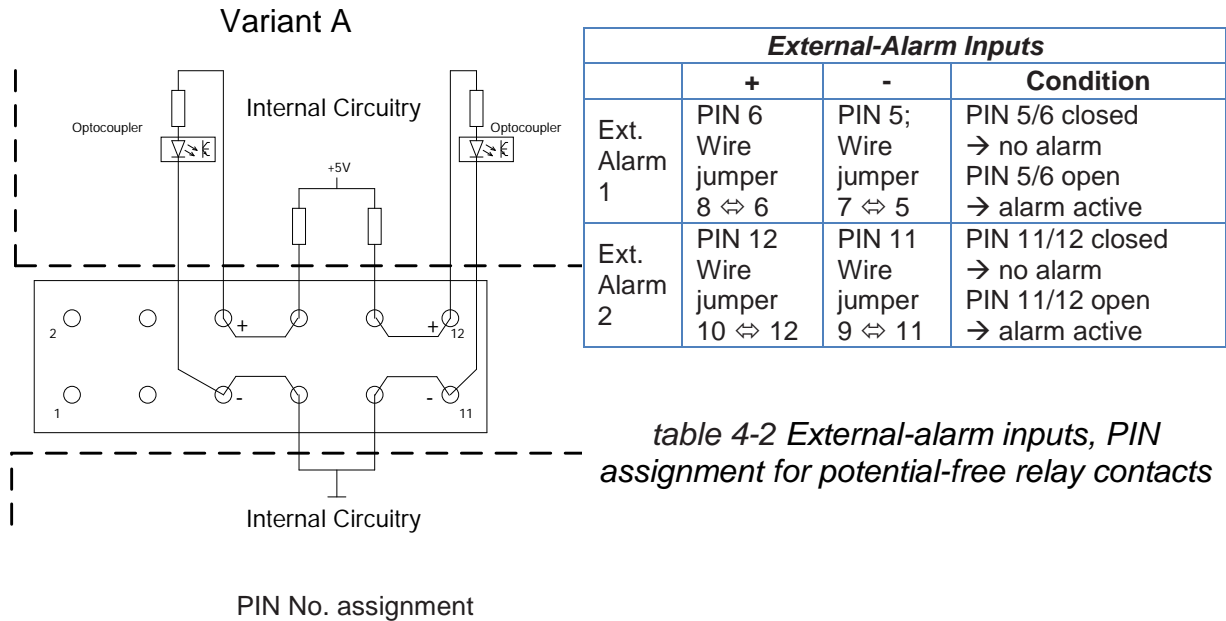

figure 4-5 External-alarm inputs, PIN assignment & potential-free relay contacts

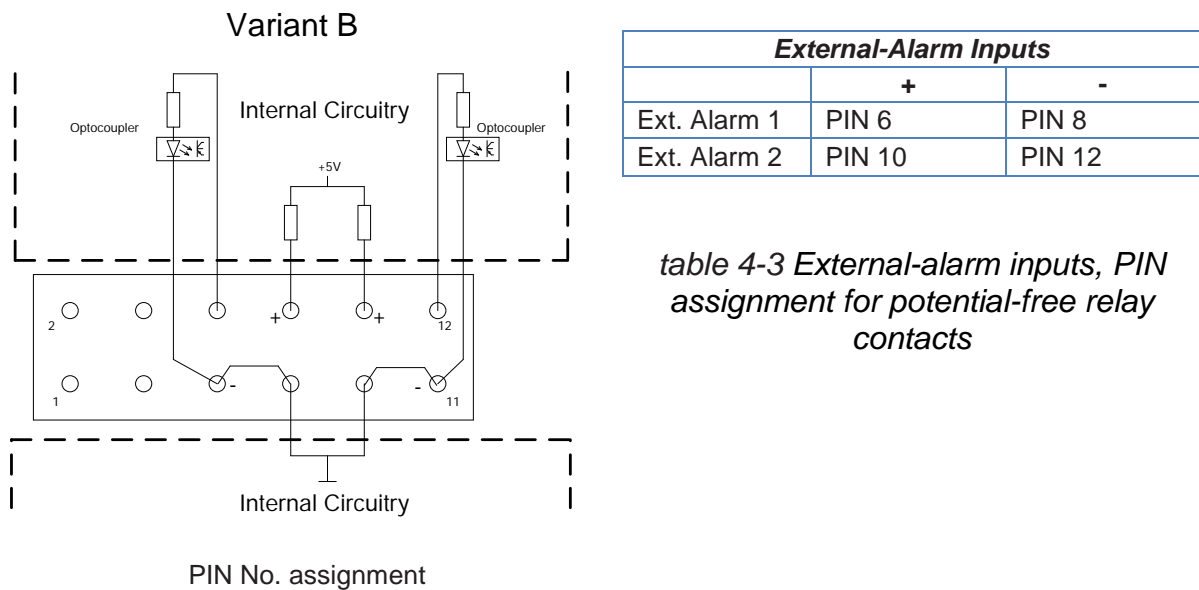

figure 4-6 External-alarm inputs, PIN assignment & potential-free relay contacts

The voltage range of the alarm inputs is 0 to 5 Vdc.

In the Alarm Settings page (see chapter 5.5.2 Settings – Alarms) a user-defined text can be assigned to the external alarms. Moreover, alarm severity and alarm logic can be changed.

4.3.2. Summary-Alarm Output

A potential-free relay contact provides a summary alarm once one or more of the alarms activated occur. The summary-alarm output consists of one normally closed contact (*open in alarm condition*), one normally open contact (*closed in alarm condition*) and the common PIN. The summary alarm comprises all alarms enabled, including the external alarms.

The contacts are rated with 50 V / 0.5 A.

The location of the connecting clamps of the summary-alarm relay is illustrated in the figure to the right:

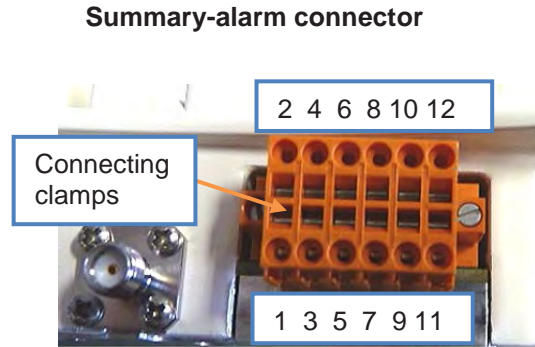

figure 4-7 Summary-alarm connector, PIN assignment

Summary-Alarm Output – Relay Contacts

Summary-alarm relay

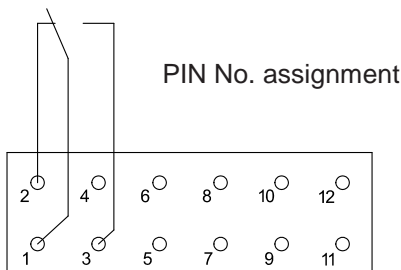

figure 4-8 Summary-alarm output, PIN assignment and relay contacts

Summary-Alarm Output	
PIN No:	Relay Contact
1	Common
2	Open in alarm condition
3	Closed in alarm condition

figure 4-9 Summary-alarm output, PIN assignment for relay contacts

5. Software Setup

5.1. Login

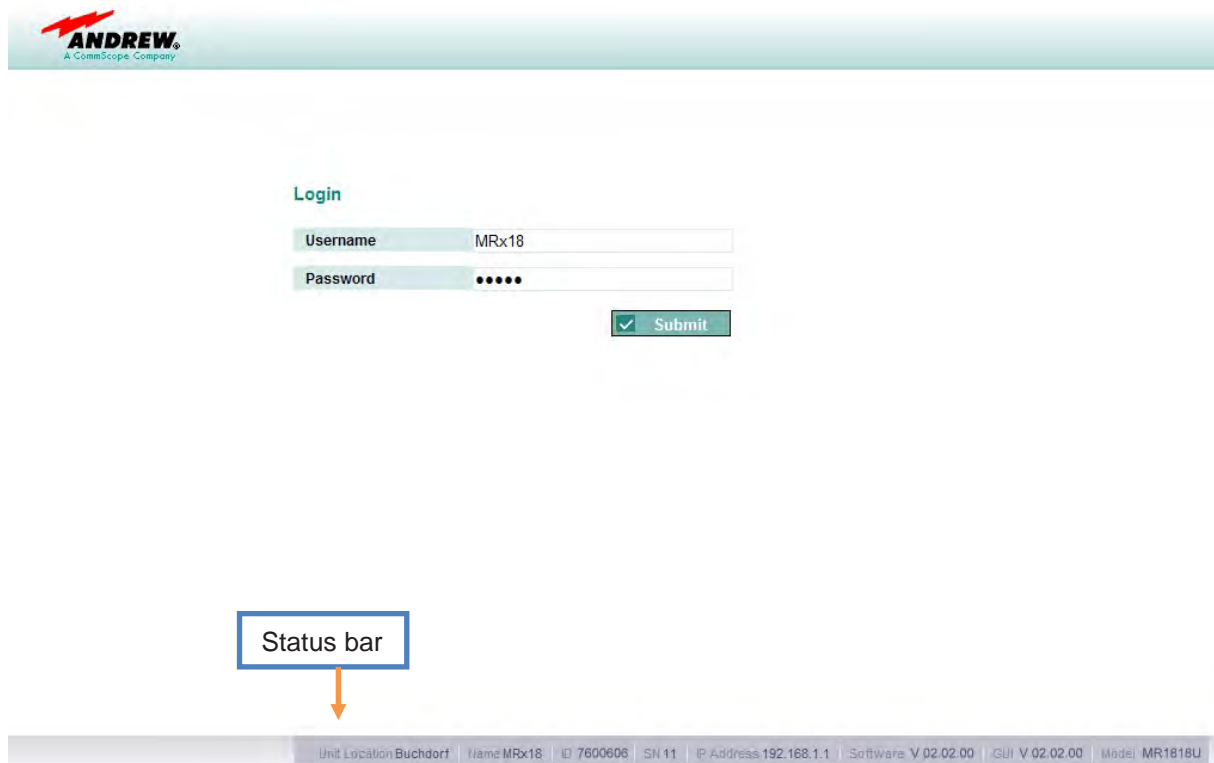

figure 5-1 Login page

Enter User name: MRx18

Enter Password: MRx18

Please note that passwords are case-sensitive when entering "MRx18".

Click the  button.

If an incorrect username or password has been entered, an error message appears. This message prompts to insert your username or password anew. Press key F5 to refresh the login mask.

If an incorrect username or password has been entered for three times, the interface to the repeater is locked for 30 minutes.

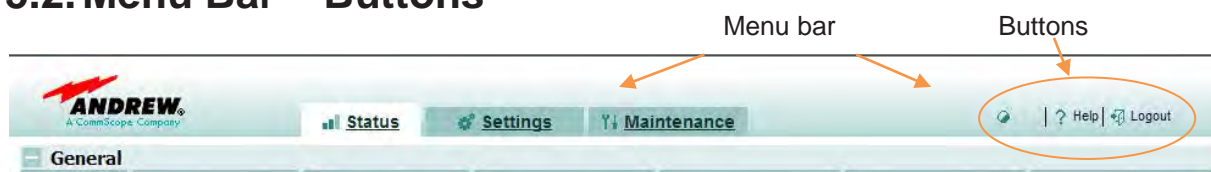

5.2. Menu Bar – Buttons



The menu bar consisting of tabs and buttons is always visible.

For description of the tabs, please refer to the following chapters.

The following buttons are provided in the menu bar (positioned on top of the right side):

Button	Explanation
	Contrast is the first button. Click the contrast button to have the webpage displayed in high contrast. To switch back into default contrast, just click on the button again and the webpage will be displayed in default contrast again. High-contrast web pages are available for the each of the Status, Settings, and Maintenance pages (an example of a high-contrast page is shown in chapter 5.4).
 Help	Help is the second button. This button provides context-sensitive help to the Status, Settings and Maintenance pages. By clicking this button, a help page for detailed information will be opened immediately. Separate Help pages are available for the Status, Settings, and Maintenance pages.
 Logout	Logout is the third button. To logout and quit the session, click this button. Then the logout page will be opened (see chapter 5.7 <i>Logout</i>).

5.3. Status Bar

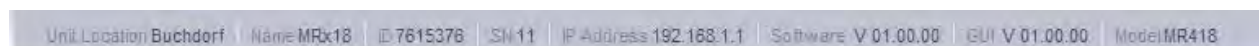

The status bar is located on the bottom of each webpage. The following information is displayed: These data is being read out of the MR418 repeater.

Designation	Description
Unit Location	Displays the unit location of the MR418 repeater – user defined area entered in chapter 5.5.3 <i>Settings – Modem Control</i> or in chapter 5.5.4 <i>Settings – LAN Connectivity</i> .
Name	Displays the designation of the repeater: MR418 – user defined, entered in chapter 5.5.4 <i>Settings – LAN Connectivity</i> .
ID	Displays the Identification Number of the MR418 repeater.
SN	Displays the Serial Number of the MR418 repeater.
IP Address	Displays the current repeater IP address set: 192.168.1.1.
Software	Displays the current software version installed.
GUI	Displays the current version of GUI (web pages) installed.
Model	Displays the specific repeater type.

table 5-1 Status bar, description

5.4. Status

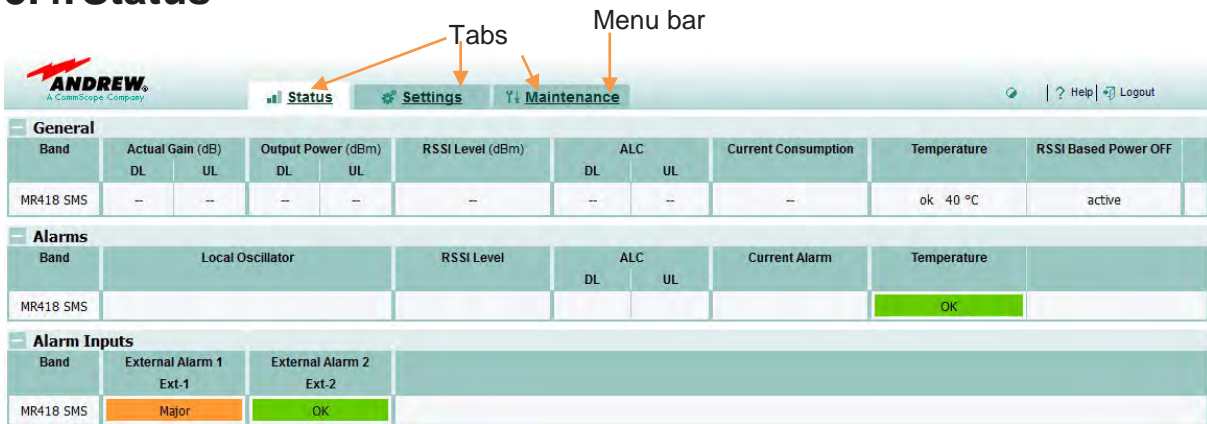

figure 5-2 Status – General & Alarms, “RSSI Based Power OFF” set to “active”

In order to show this page in high-contrast view, use the corresponding button of the menu bar (see chapter 5.2). However, in this example, the “RSSI Based Power OFF” feature was set to “not active”:

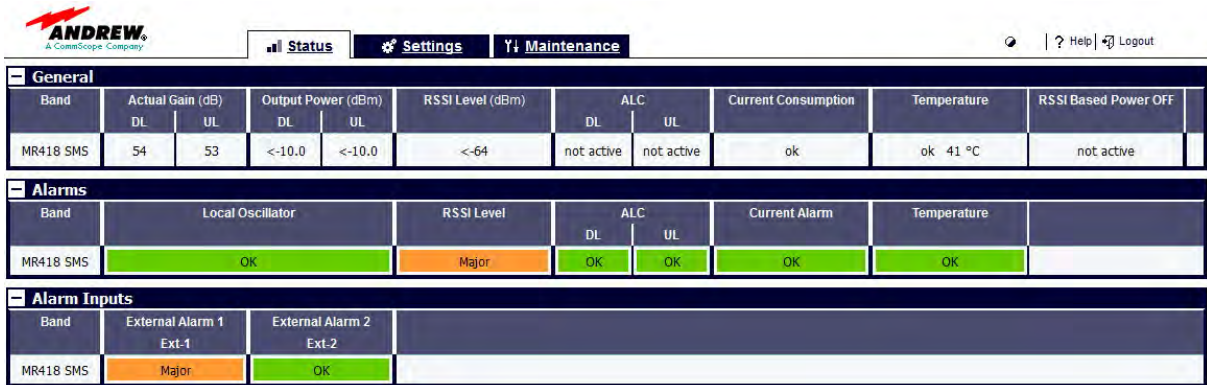

figure 5-3 Status – General & Alarms, high-contrast page

In the Status page, which is the **first** tab in the menu bar, current settings are shown. The values are referenced to the condition when the status page has been opened.

Furthermore, current alarms of the MR418 are listed in this page. No values/ alarms are captured in case the RF section is switched off (see chapter 5.5.1 *Settings – Radio Frequency*).

Button	Explanation
Refresh	This button updates the values of the Status page.
Auto Refresh	By clicking this button, the values of the Status page are automatically updated every 3 seconds. The Auto Refresh is deactivated by pressing this button once again or by leaving the Status page.

Band	Actual Gain (dB)		Output Power (dBm)		RSSI Level (dBm)	ALC		Current Consumption	Temperature
	DL	UL	DL	UL		DL	UL		
MR418	70	70	<-10.0	<-10.0	<-80	not active	not active	ok	ok 33 °C

Status - Description of General Parameters	
Band	For the single band repeater MR418 only <i>one</i> band is displayed.
Actual Gain (dB) DL/ UL	The current UL and DL gain is shown, even if Auto Gain is activated.
Output Power (dBm) DL / UL	The current measured output power in DL and UL is shown, for low output power levels “<-10.0” is displayed.
RSSI Level (dBm)	The current DL input level at the donor antenna port is indicated.
ALC DL / UL	The condition of the ALC is displayed herein. When ALC is active, the ALC limit is stated in brackets, e.g. “active (18)”.
Current Consumption	Shows if the current is within the pre-defined limits.
Temperature	The current temperature condition is displayed. If temperature rises above 80° C, an alarm is generated and the RF section of the repeater is powered down until normal temperature is reached.
RSSI Based Power OFF	The condition of the automatic RSSI Based Power OFF is displayed. If the RSSI level exceeds the RSSI power off level, the band amplifier is switched off. Possible states are ‘not active’, ‘active’ and ‘disabled’.

Band	Local Oscillator	RSSI Level	ALC		Current Alarm	Temperature
			DL	UL		
MR418	OK	Warning	OK	OK	OK	OK

Parameter	Description of Alarms	
	Cause	Solution
Band	For the single band repeater MR418 only <i>one</i> band is displayed.	---
Local Oscillator	The LO does not lock.	Restart repeater. If the error persists, contact technical support.
RSSI Level	Input signal level too low.	Check antenna alignment, donor antenna and antenna cables.
ALC DL/ UL	Input power too high.	Decrease gain, set ‘Auto Gain enabled’ or decrease input power with external attenuators.
Current Alarm	Power consumption is not within the defined range.	Restart repeater. If the error persists, contact technical support.
Temperature	Temperature too high. (>80°C)	Check installation location of MR418 and improve ventilation.

Alarm Inputs			
Band	External Alarm 1 Eingang_1	External Alarm 2 Eingang_2	
MR418	OK	OK	

Parameter	Description of Alarm Inputs
Band	For the single band repeater MR418 only <i>one</i> band is displayed.
External Alarm 1	The status of an external device can be monitored by this alarm input, alarm logic (active low / active high) can be changed and the alarm can be assigned by a user-defined name. ¹⁾
External Alarm 2	The status of an external device can be monitored by this alarm input, alarm logic (active low / active high) can be changed, and the alarm can be assigned by a user-defined name. ¹⁾

¹⁾ The user defined name is shown beyond the general text “External Alarm 1” / “External Alarm 2”

table 5-2 Status page

The severity of the alarms and settings of the alarm inputs can be changed in the Settings page (see chapter 5.5.2 *Settings – Alarms*). The latency time of each alarm is 10 seconds*, i.e. the repeater has to be in alarm condition for 10 seconds before an alarm is notified.

* Exception: The latency time of the Current Alarm was set to 60s with SW V3.1.4.



5.5. Settings

In the Settings pages – the second tab in the menu bar - current information on settings of all parameters are shown. The settings of these parameters can be changed in those pages.

The sub-tabs of the Settings page are the following:

- *Radio Frequency*
- *Alarms*
- *Modem Control*
- *LAN Connectivity*
- *User Account*

Note:

 Apply	Changed settings at the Settings pages will only become valid by clicking the Apply button. Then all changes made will be saved to the repeater.
 Logout	Additionally, changes made to Settings – LAN Connectivity and Settings – User Account require a logout by the user to make the changes valid. After a disconnection without Logout or a timeout of the session, changes in these tabs will not be applied.

5.5.1. Settings – Radio Frequency

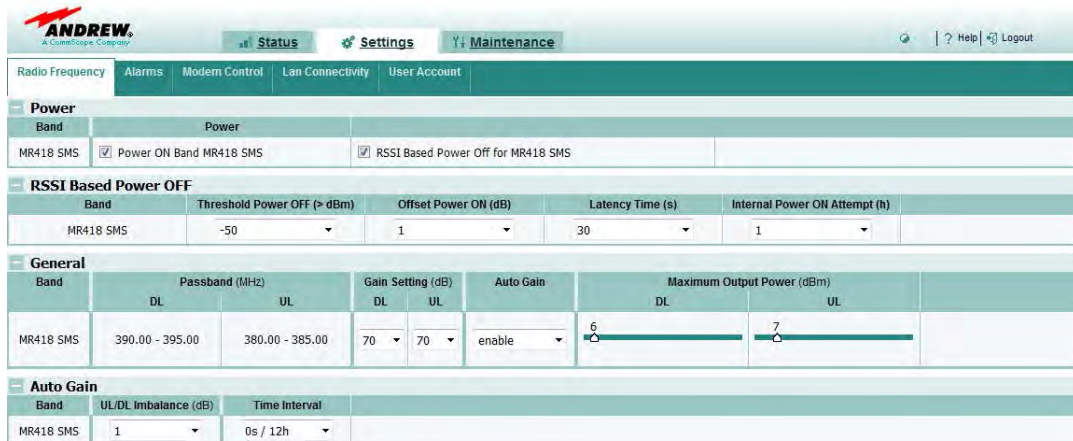

figure 5-4 Settings – Radio Frequency, exemplary

Power	
Band	Power
MR418 SMS	<input checked="" type="checkbox"/> Power ON Band MR418 SMS <input checked="" type="checkbox"/> RSSI Based Power Off for MR418 SMS

Radio Frequency - Description of Power parameters	
Band	For the single band repeater MR418 only <i>one</i> band is displayed.
Power	To power on, check “Power ON Band MR418” Uncheck “Power ON Band MR418” to power down the RF-section of the repeater. If the RF section is powered down, the band is not visible in the Settings page. Alarms and Status information are not captured in the Status page.
	Check / uncheck “RSSI Band Power Off for MR418 SMS” to switch on / disable the automatic RSSI dependent band power control. If the RSSI level exceeds the set RSSI level threshold, the band amplifiers are switched off.

RSSI Based Power OFF				
Band	Threshold Power OFF (> dBm)	Offset Power ON (dB)	Latency Time (s)	Internal Power ON Attempt (h)
MR418 SMS	-50	1	30	1

Radio Frequency - Description of RSSI Based Power OFF parameters	
Band	These settings apply for all segments in the band.
Threshold Power OFF (> dBm)	If the measured RSSI level exceeds this threshold, the amplifiers for this band are switched off. Possible settings are -20 to -50 dBm in steps of 1.
Offset Power On (dB)	Offset in dB that has to be exceeded to switch the amplifiers on again. For the above example (threshold -50 dBm, offset 1 dB) an RSSI level of -52 dBm or less switches the amplifiers on again. Possible settings are 1 to 10 dB in steps of 1.
Latency Time (s)	Latency time in seconds that the RSSI level above the RSSI threshold has to persist to cause an amplifier switch off. Possible values are in the range from 30 to 900 seconds.
Internal Power On Attempt (h)	Time interval in hours after which the RSSI is measured again for the band that has been switched off due to high RSSI level. Possible values are 0 (which means disabled) and 1 to 24 hours.

General							
Band	Passband (MHz)		Gain Setting (dB)		Auto Gain	Maximum Output Power (dBm)	
	DL	UL	DL	UL		DL	UL
MR418	390.00 - 395.00	380.00 - 385.00	70	70	enable	18	18

Radio Frequency - Description of General parameters

Parameter	
Band	For the single band repeater MR418 only <i>one</i> band is displayed.
Passband (MHz) DL / UL	The frequency range (start and stop frequency) for both DL and UL are indicated, the filter bandwidth is 5 MHz and cannot be changed.
Gain Setting (dB) DL / UL	Select the gain for UL and DL in the range from 40 dB to 70 dB. When Auto Gain is enabled the entries will not be applied.
Auto Gain	With Auto Gain activated, the repeater will automatically set its gain to the maximum value. Depending on the DL input level, gain is decreased to optimize the output power to the value adjusted at the <i>Max. Output Power (dBm) DL</i> without reaching the ALC level. Gain is increased after the time selected at Auto Gain Time Interval has expired, if the DL input level decreases. UL gain is set accordingly, depending on Auto Gain imbalance setting.
Maximum Output Power (dBm) DL / UL	The ALC limit level or maximum output power can be selected for DL and UL independently by shifting the slider to left or right.

Auto Gain		
Band	UL/DL Imbalance (dB)	Time Interval
MR418	0	0s / 24h

Radio Frequency - Description of Auto Gain parameters *

Band	For the single band repeater MR418 only <i>one</i> band is displayed.
UL/ DL Imbalance (dB)	When Auto Gain is enabled, the gain is adjusted automatically. With an entry in the Auto Gain imbalance field, the UL gain is decreased compared to the DL gain for this value.
Time Interval	<p>Possibility to select between three behaviours of Auto Gain:</p> <p>0s / 24h: Gain is reduced without latency time in case of too high input power. Every 24 hours the repeater tries to increase gain by 1 dB to max. output power in case input power has decreased again.</p> <p>0s / 12h: See above, but the interval for a try to increase gain again is 12 hours.</p> <p>10s / 12h: Gain is reduced after a latency time of 10s in case of too high input power. Interval for a try to increase gain again is 12 hours.</p> <p>10s / 24h: See above, but the interval for a try to increase gain again is 24 hours.</p>

* when Auto Gain is disabled these parameters cannot be accessed

5.5.2. Settings – Alarms

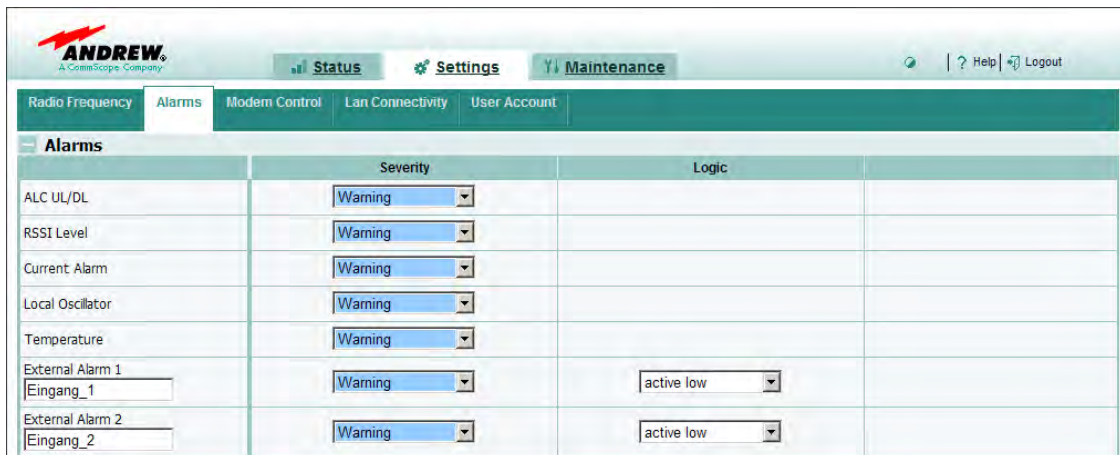

figure 5-5 Settings – Alarms

Alarms			
Parameter	Description of Severity	Logic	User Text
ALC UL/DL	A severity level can be assigned to each alarm. It is also possible to disable alarms. The severity of alarms may be: disabled, warning, minor, major, critical	---	---
RSSI Level		---	---
Current Alarm		---	---
Local Oscillator		---	---
Temperature		---	---
External Alarm 1		Selection of <i>active low</i> ¹⁾ or <i>active high</i> ²⁾ is possible.	Alarms can be designated by a user text (max. 15 characters, no special characters; no blanks).
External Alarm 2			

- 1) Alarm is raised in case the alarm input switches to *low*, alarm is cleared in case the alarm input goes to *high* condition
- 2) Active high: alarm is raised in case the alarm input switches to *high*, alarm is cleared in case the alarm input goes to *low* condition

5.5.3. Settings – Modem Control

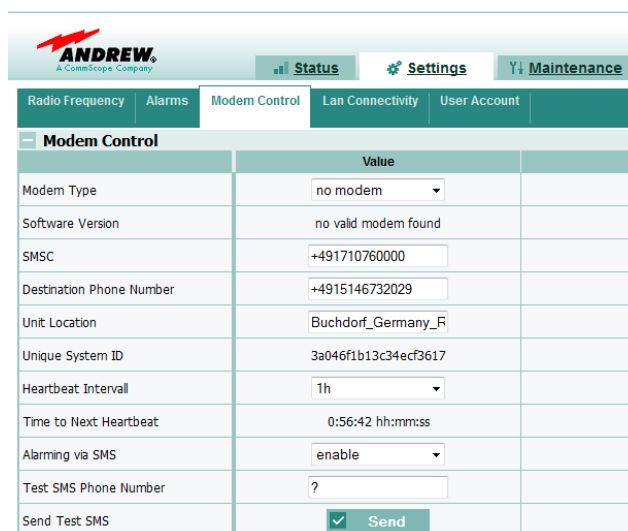

figure 5-6 Settings – Modem Control

Description of Modem Control Value Parameters	
Modem Type	Different modems can be selected for SMS remote monitoring. If a modem is connected to the repeater, it is automatically initialized during the boot process of the repeater. If no reboot is performed, the modem type has to be selected manually. ¹⁾
Software Version	The software version of the modem supplied with the repeater is shown. If no modem is connected or the modem cannot be recognized the message "no valid modem found" appears.
SMSC	The Service Center Phone Number (SMSC) is entered here (including country code, +CC, e.g. +49 for Germany). If the SMSC is stored to the SIM card of the modem, no entry needs to be done.
Destination Phone Number	Both the number of the destination for alarm messages and heartbeat SMS and the sender for SMS are determined herein. The number should be preceded by the country code (i.e. +CC, e.g. +49 for Germany). Only decimal digits are allowed, no spaces. The phone number shall consist of min. 7 decimal digits, max. 20 decimal digits.
Unit Location ²⁾	The Unit Location is sent with each SMS to get information about e.g. address location or building where the repeater is installed. No validation is done with the entry. The Unit Location is a user-defined field. The content of Unit Location on the Modem Control page corresponds to that of the Unit Location on LAN Connectivity page. The settings are only applied in the status bar at the bottom of each page after a new login. A maximum of 20 characters are allowed; however, no special characters (like e.g. #, ", &), no blanks, and no numbers.
Unique System ID ²⁾	The Unique System ID is for identification of the repeater within A.I.M.O.S. software. This field is read-only.
Heartbeat Interval	A heartbeat SMS is sent after a certain period of time that can be selected in this field. The heartbeat indicates that the supervision of the repeater is working. If no heartbeat message is sent after the interval entered, the connection and supervision is down. If heartbeat interval is set to "0", the heartbeat functionality is disabled.
Time to Next Heartbeat	Depending on the heartbeat interval the time that still remains until the next heartbeat will be sent is indicated.
Alarming via SMS	The alarming via SMS can be disabled in case no alarm and heartbeat SMS shall be sent to the destination phone number. However, settings can be changed or the status of the repeater can be queried via SMS, when Alarming via SMS is disabled.
Test SMS Phone Number	To check connectivity of the modem, a test SMS can be sent to a different receiver, e.g. your own mobile. The test SMS will contain Unit Location, Modem RSSI level, date, and timestamp.
Send Test SMS	Click this button to send a test SMS to the receiver entered in Test SMS Phone Number field.

¹⁾ Exception: Apart from the external modem, the MR418 can also be equipped with an internal modem. The internal modem is not automatically initialized, it has to be activated manually. If the message "no valid modem found" appears after selecting the internal modem and executing "Apply", no internal modem has been equipped.

²⁾ With integration in A.I.M.O.S. a configuration SMS is sent from A.I.M.O.S. that overwrites the entries of these fields by the entries coming from A.I.M.O.S.

table 5-3 Settings - Modem Control

To make the changes valid, the Apply button has to be pressed and the user has to log out.

5.5.4. Settings – LAN Connectivity

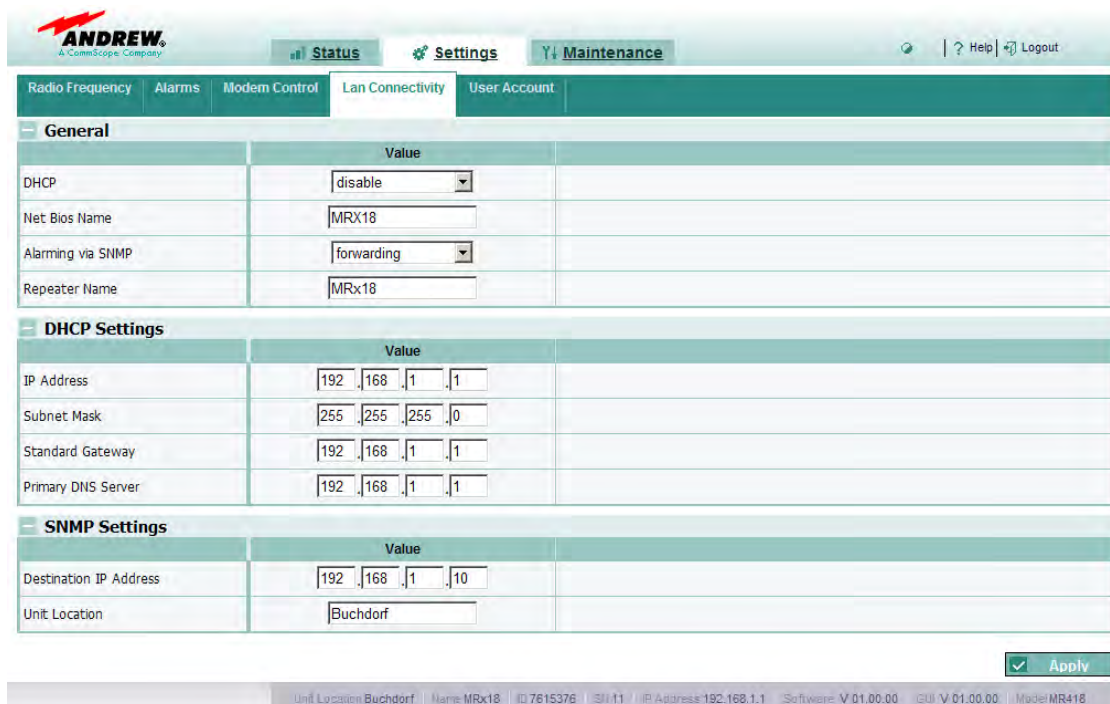

figure 5-7 Settings – LAN Connectivity

LAN Connectivity – General	
Parameter	Description of Value
DHCP	Default setting is DHCP disabled. With DHCP (Dynamic Host Configuration Protocol) enabled the repeater receives its IP address from the server of the LAN network. No entries for IP Address, Subnet Mask, Standard Gateway and Primary DNS Server (DHCP Settings) can be made when DHCP is enabled. * DHCP must only be enabled when the repeater is connected to LAN.
Net BIOS Name	If Net Bios Name is supported by the LAN the repeater is connected to, the repeater can be accessed by entering the Net Bios Name in the explorer instead of the IP address. A maximum of 15 characters are allowed for the Net Bios Name.
Alarming via SNMP	Three options can be selected for alarming via SNMP: Disable: Alarming via SNMP is deactivated. Forwarding: SNMP V1 traps of active alarms (including external alarms) are sent to a user-defined destination IP address. The destination IP address must be entered beyond the item ‘SNMP Settings’. Polling: The status of the alarm can be queried. A static alarm table, comprising the alarms of the MR418 and the external alarms, as well, provides the status of those alarms (a detailed description of SNMP polling is provided in chapter 7.3).
Repeater Name	For identification, the repeater name can be changed. No validation is done with the repeater name. Max. 15 characters are allowed, however, no special characters (like e.g. #, “, &); no blanks. The settings are only applied to in the bar at the bottom of each page after a new log in.

To make the changes valid the Apply button has to be pressed and the user has to log out.

DHCP Settings	
	Value
IP Address	192 .168 .1 .1
Subnet Mask	255 .255 .255 .0
Standard Gateway	192 .168 .1 .1
Primary DNS Server	192 .168 .1 .1

LAN Connectivity – DHCP Settings *	
IP Address	The IP address of the repeater can be changed herein. **
Subnet Mask	The Subnet Mask can be changed herein. **
Standard Gateway	The Standard Gateway can be changed herein. **
Primary DNS Server	The primary DNS server can be changed herein. **

* **Note:** When *DHCP* is enabled no entries can be made.

To make the changes valid the Apply button has to be pressed and the user has to log out.

SNMP Settings	
	Value
Destination IP Address	192 .168 .1 .10
Unit Location	Buchdorf

LAN Connectivity – SNMP Settings *	
Parameter	Description of Value
Destination IP Address	If 'forwarding' of alarms via SNMP is selected, the destination IP address where the alarms traps ought to be sent to has to be entered.
Unit Location	The Unit Location is sent with each SMS to get information about e.g. address location or building where the repeater is installed. No validation is done with the entry. The Unit Location is a user-defined field. The content of Unit Location on the Modem Control page corresponds to that of the Unit Location on the LAN Connectivity page. The settings are only applied to in the status bar at the bottom of each page after a new login. A maximum of 20 characters are allowed; no special characters (like e.g. #, ", &), no blanks, and no numbers.

* When "polling" or "disabled" is selected at *Alarming via SNMP*, these parameters cannot be accessed.

To make the changes valid the Apply button has to be pressed and the user has to log out.

5.5.5. Settings – User Account

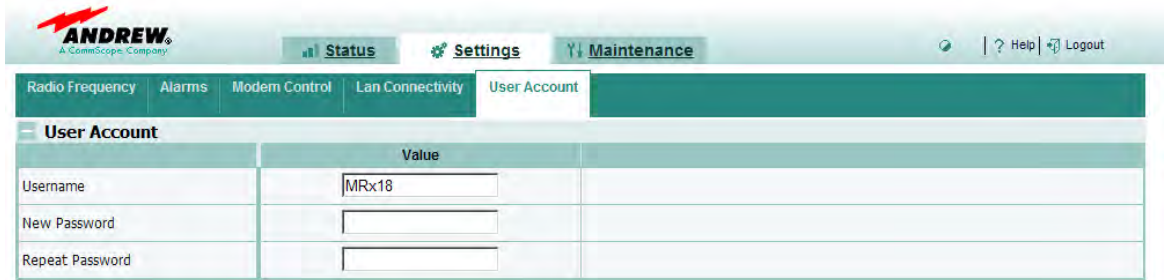

figure 5-8 Settings – User Account

User Account	
Parameter	Description of Value
Username	To login the user name is required. The default user name can be changed. Max. 8 characters are allowed; however no special characters (like e.g. #, “, &); no blanks. *
New Password	The password to login can be changed. Max. 8 characters are allowed; however, no special characters (like e.g. #, “, &); no blanks. The new password must be repeated. *
Repeat Password	

table 5-4 Settings – User Account page

To make the changes valid the Apply button has to be pressed and the user has to log out.

5.6. Maintenance

The screenshot shows the Andrew Maintenance page. At the top, there are navigation tabs for Status, Settings, and Maintenance. The Maintenance tab is active. Below the navigation, there are three main sections:

- Modem Debugging:** A table with columns: Location Area Code, MCC / MNC, Cell Information, RSSI (dBm), and Software Version. The values are: no network, no network, no network, -100, and no valid modem found.
- Software Update:** A section titled "Guide for Windows" with a list of 8 steps:
 - Step1: Disconnect MRx18 from mains power
 - Step2: Save software file MRx18Vxxx.hex to the hard disk of the PC, e.g. to C:\Temp
 - Step3: Connect CAT6 patch cable to the Ethernet port of the MRx18 and network connector of the PC
 - Step4: Open command prompt (Windows Start Menu -> Run) and enter cmd
 - Step5: After cmd.exe has been opened, type: `ftp 192.168.1.2 PUT "C:\directory the file is saved to\MRx18Vxxx.hex"` - do not press the return button
 - Step6: Connect MRx18 to mains power
 - Step7: Press the return button during the boot process (ALC LED is flashing for four seconds)
 - Step8: After successful software upload, the MRx18 reboots automatically
- Webpage Update:** A section with a text input field for ".bin file", a "Durchsuchen..." button, and an "Upload" button.

figure 5-9 Maintenance

In the Maintenance page current information on the modem is available (e.g. cell information). Moreover, the web pages can be updated and a guide to update the MR418 software is provided here.

Modem Debugging					
Location Area Code	MCC / MNC	Cell Information	RSSI (dBm)	Software Version	
no network	no network	no network	-100	no valid modem found	

Maintenance	
Parameter	Description of Modem Debugging
Location Area Code	The Location Area Code of the existing server cell is indicated. This information is provided by the modem applied. "No network" is stated in case no modem is connected or is recognized to/by the repeater or the modem is not able to access to a mobile network.
MCC / MNC	The Mobile Country Code (MCC) and Mobile Network Code (MNC) of the server cell are indicated. The first three digits show the MCC, the last two digits the MNC. The MCC and MNC are detected by the modem applied. "No network" is stated in case no modem is connected or is recognized to/by the repeater or the modem is not able to access to a mobile network.
Cell Information	The cell information displays the ID of the cell the modem is served. "No network" is stated in case no modem is connected or is recognized to/by the repeater or the modem is not able to access to a mobile network.
RSSI (dBm)	The received signal level at the antenna port of the modem is displayed. "No network" is stated in case no modem is connected or is recognized to/by the repeater or the modem is not able to access to a mobile network.
Software Version	The software version of the modem connected to the repeater is shown. If no modem is connected or the modem cannot be recognized, the message "no valid modem found" appears.

Software Update	
Guide for Windows	
Step1	Disconnect MRx18 from mains power
Step2	Save software file MRx18Vxxx.hex to the hard disk of the PC, e.g. to C:\Temp
Step3	Connect CAT6 patch cable to the Ethernet port of the MRx18 and network connector of the PC
Step4	Open command prompt (Windows Start Menue -> Run) and enter cmd
Step5	After cmd.exe has been opened, type: ftpp 192.168.1.2 PUT "C:\directory the file is saved to\MRx18Vxxx.hex" - do not press the return button
Step6	Connect MRx18 to mains power
Step7	Press the return button during the boot process (ALC LED is flashing for four seconds)
Step8	After successful software upload, the MRx18 reboots automatically

Maintenance	
Parameter	Description of Software Update
Guide for Windows	The procedure how to update the repeater software.

For software update, please also refer to chapter 5.8 Upload New Software Version.

Note: Observe that SW and GUI (webpage file) always have to be updated to the same version.





Maintenance	
Webpage Update	Description
Choose .bin file	The web pages can be updated by uploading the .bin file. Choose the bin file by clicking  and then click  to upload and update the webpage.

table 5-5 Maintenance page, description

5.7. Logout

The Logout page can be accessed by clicking , which is the **third** button on top of the menu bar.

By clicking the **Logout** button, the session will be quit and the Login Page opened:

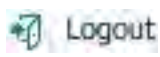

Login

Username

Password



figure 5-10 Logout

Logout is possible from the Status, Settings, and Maintenance pages at any time.

Note: Settings made in LAN Connectivity and User Account will only become valid after the user has executed a manual logout.

5.8. Upload New Software Version

The software can be updated. The new software version is delivered as MR418Vxxx.hex file.

Observe that from Windows 7 onwards the TFTP-Client required for the upload is deactivated by default. Therefore, it has to be activated via Control Panel → All Control Panel Items → Programs and Features → Turn Windows features on or off:

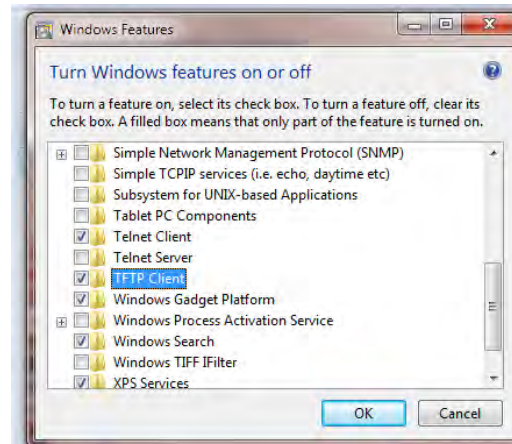

Note: Observe that SW and GUI (webpage file) always have to be updated to the same version.

- Disconnect the MR418 from mains power.
- Save the new software version file to a folder on the hard disk or USB-stick of the laptop or PC, e.g. to C:\Temp.
- For **local** connection, connect the **straight** CAT 6 patch cable to the Ethernet connector of the MR418 and the network connector of a laptop or PC. For MR418 connection to a **LAN** network, connect the **cross-over** cable.
- Open a command prompt (Start – Run...- cmd) and enter:
tftp 192.168.1.2 PUT "C:\Temp\MR418Vxxx.hex" (Do not press the return button yet).

```

C:\WINDOWS\system32\cmd.exe
C:\Documents and Settings\rapanlilio>tftp
Transfers files to and from a remote computer running the TFTP service.
TFTP [-i] host [GET | PUT] source [destination]

  -i          Specifies binary image transfer mode (also called
             octet). In binary image mode the file is moved
             literally, byte by byte. Use this mode when
             transferring binary files.
  host       Specifies the local or remote host.
  GET        Transfers the file destination on the remote host to
             the file source on the local host.
  PUT        Transfers the file source on the local host to
             the file destination on the remote host.
  source     Specifies the file to transfer.
  destination Specifies where to transfer the file.

C:\Documents and Settings\rapanlilio>tftp 192.168.1.2 PUT "C:\Temp\MR418V100.hex"

```

figure 5-11 Upload new software version

- Provide power to the MR418 and press the return button of the laptop or PC during the boot process (i.e. red ALC LED is blinking for four seconds).

After the software upload, the MR418 will reboot automatically.

Note: Only the software is updated, the configuration settings made before the update are not changed.

If the software upload had not been successful, it might be necessary to set the IP address of the PC or laptop to a fixed IP, e.g. to 192.168.1.10 (please see chapter 5.5.4 Settings – LAN Connectivity).

6. Optional Equipment

6.1. External Modem (Kit)

As an option, the MR418 can also be equipped with an external modem for remote monitoring via SMS. Alarms are forwarded to A.I.M.O.S. or an SMS receiver. Settings can be changed by commands sent from A.I.M.O.S. or an SMS receiver.

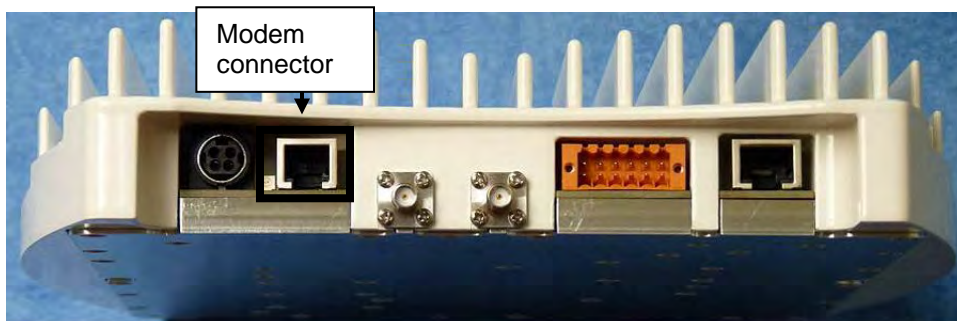

figure 6-1 Position of modem connector

In case a common antenna is required to serve the modem and MR418, an external coupler will be necessary. Inside the MR418 no coupler is integrated.

Note: In order to guarantee proper operation for remote monitoring function via SMS, the minimum GSM level has to be >-100 dBm at the modem antenna port.

Several modems are available as kits.

Further information is available in a separate manual, which can be downloaded as well.

6.2. Integrated Modem

Depending on the configuration, the MR418 contains an integrated modem for remote monitoring via SMS. The antenna port for the integrated modem is located next to the BTS connector (see following illustration). No modem coupler is implemented in the MR418; in case a common antenna is intended to be used, an external coupler will be necessary.

Note: In order to guarantee proper operation for remote monitoring function via SMS, the minimum GSM level has to be > -100 dBm at the modem antenna port.

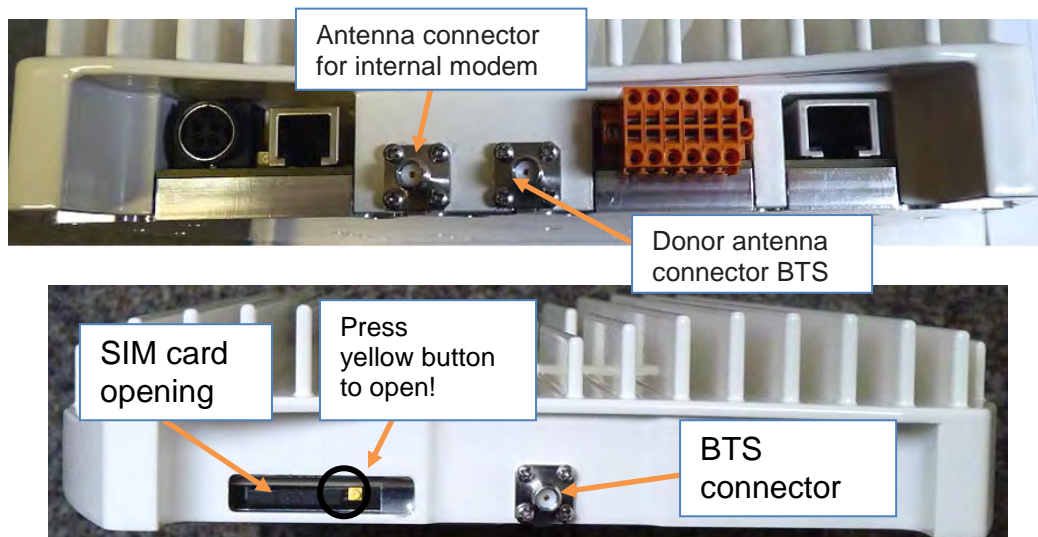

figure 6-2 SIM card opening and BTS connector

Further information will be available in a separate manual.

6.3. Antenna

An omni-directional multi-band coverage antenna can be directly mounted to the MR418 antenna port – labelled with “Mobile”, as illustrated to the right.



figure 6-3 Coverage antenna for MR418, optional equipment

6.4. Adapter Cable

Cables with SMA male to N-female connectors can be ordered, if required. The length of the cable is 500 mm.

7. Alarming and Supervision

For alarming and supervision, the MR418 is provided with an alarming interface represented by three LEDs. Several pieces of information can be queried by the display without connecting a PC or laptop locally to the MR418.

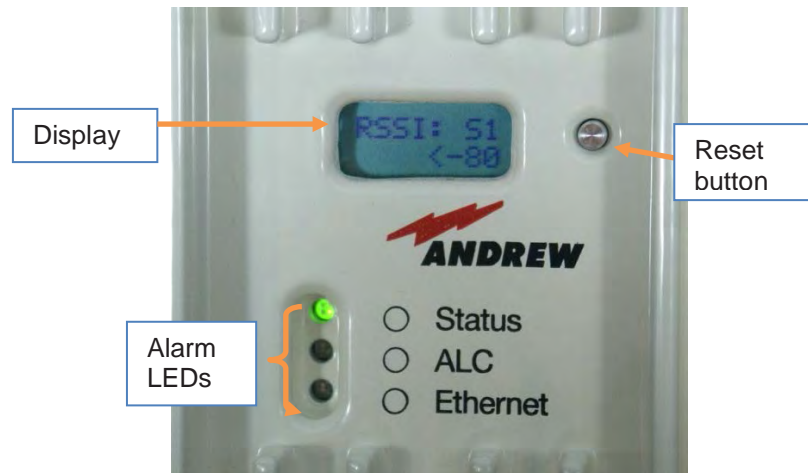

figure 7-1 Display and alarm LEDs, exemplary

7.1. Alarm LEDs

Denotation of LED	Colour	Function/ Indication
Status	Green	A green light indicates the normal operation of the repeater. Power is present and the current consumption of the unit is within the specifications.
	Orange	An orange light indicates that current consumption of the repeater is not within defined limits or the LO cannot lock and the repeater might not work properly.
	Off	If the LED is off, the respective MR418 does not receive any DC power.
	Red	A red light indicates the temperature alarm, which switches to power-down mode once an over-temperature has been reached. The temperature sensor of the controller will continue to check the temperature in power-down mode. As soon as the temperature has returned to normal, the controller will enable the RF-section.
	Blinking red/green	Blinking red/green indicates the antenna alignment assistance for approx. four minutes.

Denotation of LED	Colour	Function/ Indication
ALC	Off/ red	A red LED indicates that the input power received by the repeater is too high. The output power of the repeater must be limited. This will be done by the ALC. Limitation of power ensures that the final stage is not overdriven and that intermodulations are kept below the limits.
	Blinking red	The LED is blinking red for four seconds during the boot process.
Ethernet	Off/ green	The LED is green if the repeater is connected via Ethernet. LED is blinking during data transfer via Ethernet connection.

table 7-1 Alarm LEDs

7.2. Display and Reset & Installation Assistance Button

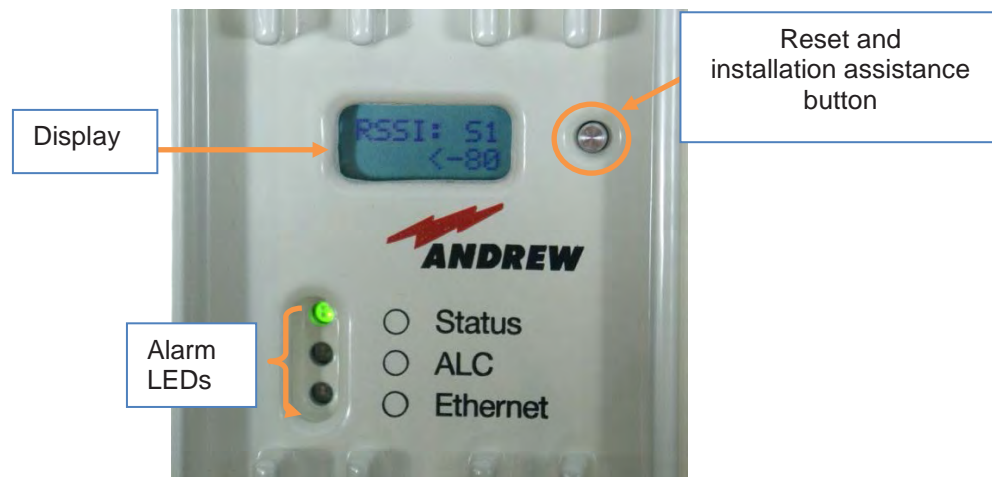
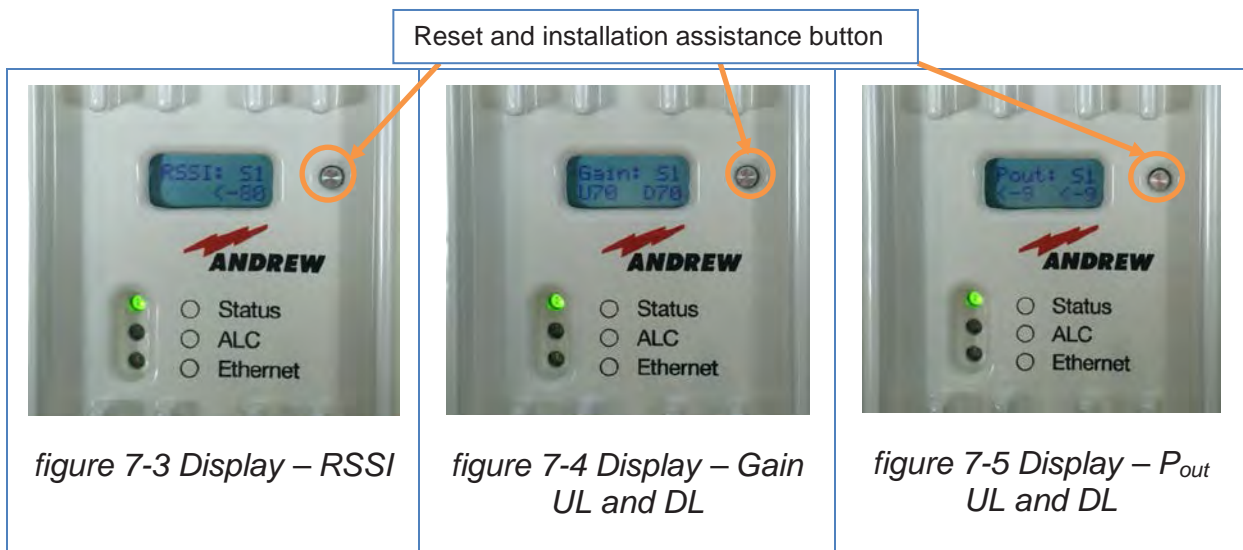

figure 7-2 Display with reset button and alarm LEDs , exemplary

Functions of the Reset Button:

- **To align the donor antenna** of the MR418 towards the BTS via the antenna alignment assistance (as described in chapter 4.2 *Electrical Installation*), press the “Reset and installation assistance” switch (illustrated in figure above) for at least *four* seconds **after** (!) the boot process has been finished (i.e. red ALC LED is blinking for four seconds). This will set the gain to max. value and disable Auto Gain for about 4 minutes. The status LED will be blinking red/green. Align the donor antenna towards the BTS tower to reach the highest RSSI level possible. Check the RSSI level at the display (see chapter 7 *Alarming and Supervision*). After four minutes, the gain and Auto Gain are adjusted to the same values prior to the activation of the antenna alignment.

- **To activate the display from sleep mode** this button has to be pressed. Even when an alarm is raised, the display will not be switched on. Thus, active alarms are initially only indicated by the LED's until the button is pressed. Then, the alarm information is indicated on the display. The display will be switched off automatically after 10 minutes even if an existing alarm is indicated on the display.
- **To reset Ethernet settings, username and password** to the default factory settings, press the 'Reset and installation assistance switch' during the boot process (i.e. red ALC LED is blinking for four seconds after power has been supplied) and keep the switch pressed until the boot process starts again (Ethernet LED starts blinking). It is not possible to execute a reset when a local connection is established.
- By pushing the reset and installation assistance button (illustrated in figure above), several pieces of **status information of the MR418 can be queried**. Information given is on RSSI, current gain UL and DL, current output power UL and DL (abbreviated by Pout in the display). The reset and installation button is used to switch between the status information in the following sequence:
RSSI → Gain → Output power



In alarm condition the display shows* the segment and kind of alarm. When the MR418 is in normal operation with no active alarms, "System Ok" is indicated.

* When the display is in sleep mode it has to be activated by the "Reset and installation assistance button", first.

Note: When the MR418 is switched to "power down" the respective segment is shown in the display.

7.3. SNMP Polling

7.3.1. Requirements

MIB MRx18 (available from the Technical Support of CommScope)
 SW version 1.0.5 or higher of MR418 software
 MIB browser

7.3.2. MIB Tree

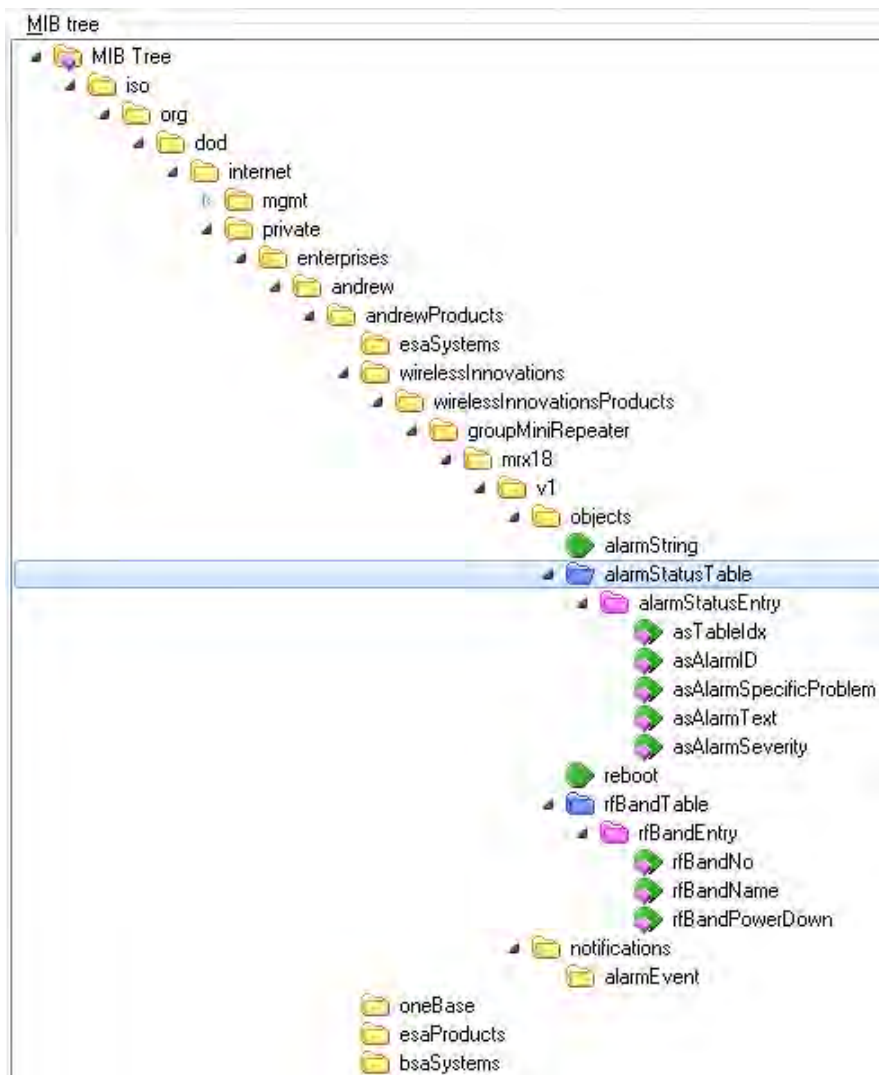

The complete Alarm Status Table is read only, for other leaves see following table.

reboot	Read and write (see example 1): 1 = true (reboot); 2 = false
rfBandTable	read only (see example 2)
rfBandEntry	read only
rfBandNo	read only
rfBandName	read only
rfBandPowerDown	Read and write (see example 3): 1 = true (Power down); 2 = false (Power up)

7.3.3. Examples

1. Reboot Get command:

```

Query results
-----
Remote address: 192.168.1.1 port: 161 transport: IP/UDP
Local address: 192.168.1.10 port: 59064 transport: IP/UDP
Protocol version: SNMPv1
Operation: Get
Request binding:
1: reboot.0 (INTEGER) null

Response binding:
1: reboot.0 (INTEGER) false(2)
    
```

2. rfBandTable Walk command:

```

***** SNMP QUERY STARTED *****
1: rfBandNo.1 (INTEGER) 1
2: rfBandName.1 (OCTET STRING) MR418 Segment 1
3: rfBandPowerDown.1 (INTEGER) false(2)
***** SNMP QUERY FINISHED *****
    
```

3. rfBandPowerDown Set command:

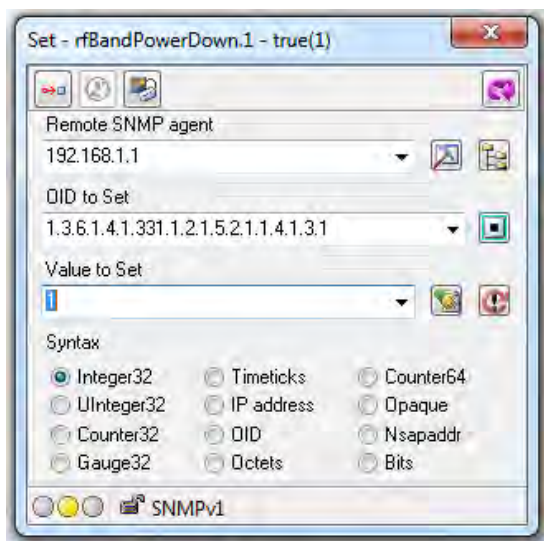

8. Appendix

8.1. Electrical Specifications

Electrical		
Frequency range *	UL	380 to 385 MHz; 410 to 415 MHz; 415 – 420 MHz
	DL	390 to 395 MHz; 420 to 425 MHz; 425 – 430 MHz
Duplex spacing		10 MHz
RF output power	UL / DL	+19 dBm @ 1 carrier +16 dBm @ 2 carriers
OICP3	UL / DL	+43 dBm
P-1dBc	UL / DL	+30 dBm
Noise figure UL / DL	Maximum gain	6.0 dB
Spurious emission / ACPR		-36 dBm @ 18 kHz
Gain		70 dB
Gain adjustment range		30 dB in steps of 1 dB
Bandwidth options		5 MHz
Flatness		±2 dB
Delay		7.5 µs
Power supply	Mains power	100 to 240 Vac
	Local power	6 Vdc
Power consumption		30 watts
Antenna port	Connector	SMA Female
	Return loss	10 dB
System Supervision and Control		
Alarms	Temperature, Current, ALC	
Alarm inputs	2 external-alarm clamps	
Alarm outputs	Summary alarm contact	
Options	Remote control and Heartbeat via GSM SMS	

* others available on request
All figures are typical values.

8.2. Environmental and Safety Specifications

Note: The specifications for environmental and safety conditions are according to ETS 300 019 (European Telecommunication Standard). For further details, please refer to the “Environmental and Safety Specifications” leaflet of the supplier.

Operating temperature range	+5°C to +40°C
Ingress protection	IP30

All data is subject to change without notice.

8.3. Mechanical Specifications

Height, width, depth	270 x 240 x 45 mm (10.6 x 9.5 x 1.8 in)
Weight	3.2 kg (approx. 7.1 lb)

All data is subject to change without notice.

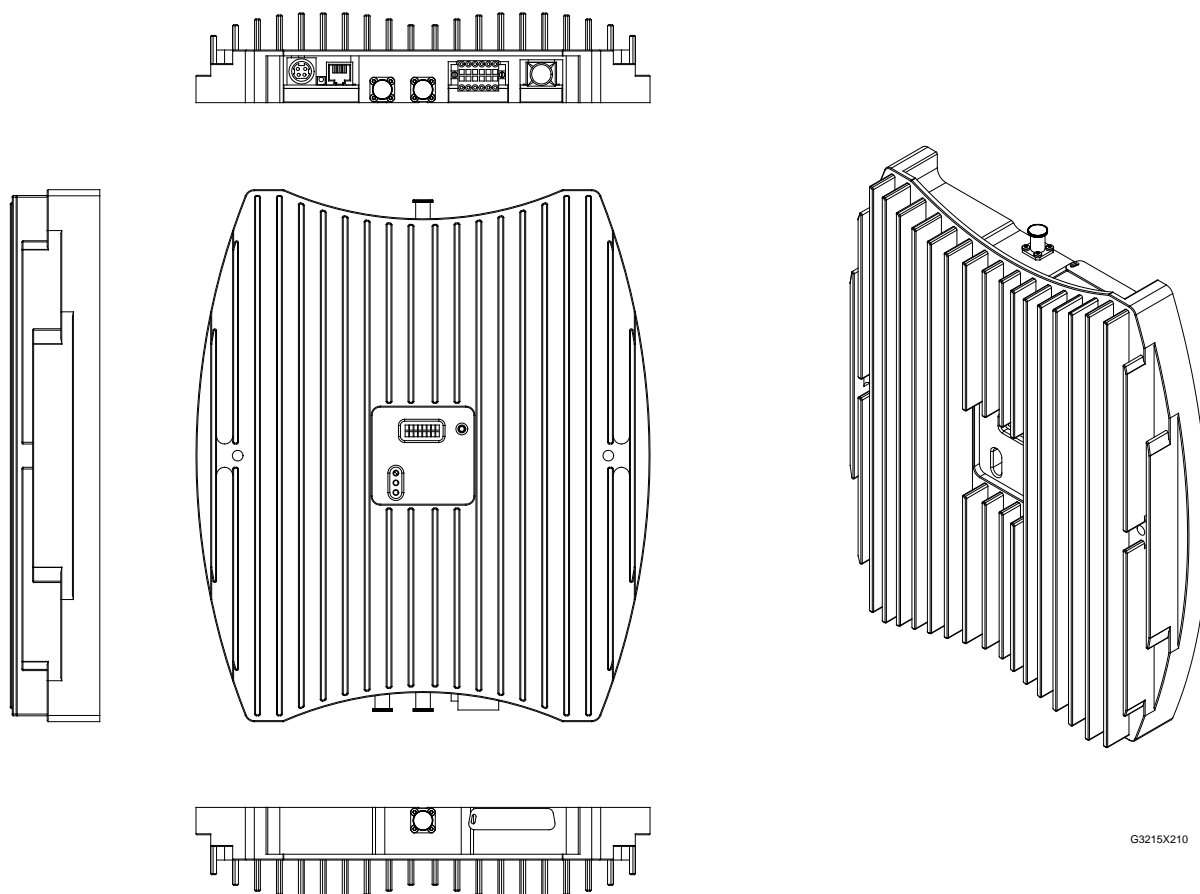

G3215X210

figure 8-1 Cabinet drawing MR418

8.4. Spare Parts List

Note: When sending back the unit, use an appropriate packaging. We strongly recommend using the original packaging.

Repeaters:	ID No:
MR418 380-385 390-395 MHz	7613614
MR418 410-415 420-425 MHz	7615374
MR418 415-420 425-430 MHz	7625001

PSU Kit AC IN 100-240 V / OUT 6 V 30 W AUS	7563232
PSU Kit AC IN 100-240 V / OUT 6 V 30 W EURO	7563219
PSU Kit AC IN 100-240 V / OUT 6 V 30 W IND	7563220
PSU Kit AC IN 100-240 V / OUT 6 V 30 W UK	7563233
PSU Kit AC IN 100-240 V / OUT 6 V 30 W USA	7563234
PSU Kit AC IN 100-240 V / OUT 6 V 30 W ZA	7563231

Modem-Kit EGS5 MRx18*	7615377
Modem-Kit EGS5-3 MRx18	7721516

Antenna 370-512	7615115
RF Cable-Kit SMA to N 500 mm	7594320

* The Modem-Kit EGS5 is discontinued and will be replaced by Modem-Kit AEGS5-2 MRx18.

Last Replaceable Unit (LRU) is the entire miniRepeater MR418 listed above, except for the manual, the power supply kits, and the optional equipment (antennas, RF cable kit and modem kits) listed above.

Note: To ensure compatibility with your system, do not order any individual components (e.g. modems) of the kits available! Make sure to always order the complete kit (ID must be listed above) as spare part.

The manufacturer reserves the right to replace the spare parts listed above by equivalent substitutes!

9. Index

A	
Abbreviations.....	6
Adapter Cable.....	39
Alarm Inputs	27
Alarms	26
Auto Refresh.....	25
C	
CommScope.....	9
Compliance.....	8
Connectivity	33
Connectors	15
Contact Addresses, Customer Support	11
Contrast (High) Page.....	24
Contrast Button.....	24
Coverage Antenna.....	39
D	
DC Connector.....	17
Declaration of Conformity (DoC).....	9
Display.....	40
E	
External-Alarm Inputs, Connector.....	20, 21
External-Alarm Inputs, Relay Contacts.....	20
F	
Functional Description.....	14
H	
Health and Safety.....	7
Help.....	24
I	
Installation	
Antenna Alignment Assistance	17
Electrical	16
Integrated Modem	38
Introduction.....	12
IP Address.....	18
L	
LEDs.....	40
Logout	24, 36
M	
Maintenance.....	35
Modem Debugging	35
Software Update	35
Webpage Update.....	36
Menu Bar, Buttons.....	24
Modem Connector (External)	38
Modem Control.....	31
Modem Kit (External).....	38
O	
Optional Equipment.....	38
P	
Password.....	34
Property Damage Warnings	7
R	
Radio Frequency Settings	28
Remote Monitoring via SMS.....	38
Reset Button.....	15, 17, 41
Reset to Default.....	19
S	
Set	
Auto Gain.....	29
Gain	29
Output Power.....	29
Power-Down	29
Settings	27
Alarms	30
DHCP	32
LAN connectivity	32
Modem Control	31
Radio Frequency	28
SNMP	33
User Account	34
SNMP	33
Polling.....	43
Software Setup.....	23
Software Upload.....	36, 37
Software Version	36, 37
Spare Parts List.....	47
Specifications	
Electrical	45
Environmental and Safety.....	45
Mechanical	46
Status	25
Status Bar.....	24
Summary-Alarm Output.....	22
Supervision.....	40
System Overview.....	12
T	
Troubleshooting.....	26
W	
Web-based Browser	23

10. List of Changes

Version	Changes	Release Date
M0139AJG		19-August-2015
M0139AJH	<ul style="list-style-type: none">- Chapters 1.1 and 1.4 updated, Class B added- RSSI Based Power Off added in chapter 5.4- RSSI Based Power Off and new autogain time interval added in chapter 5.5.1- Test SMS added in chapter 5.5.3- Unit Location information updated in chapters 5.5.3 and 5.5.4- New modem kit added and SMS units deleted in chapter 8.4	28-February-2018

COMMSCOPE®