

COMMSCOPE®

Modem Kit EGS5(-3)

for

MRx18



Remote Monitoring Option – SMS

User's Manual
M0139AKH

DISCLAIMER:

This document has been developed by CommScope, and is intended for the use of its customers and customer support personnel. The information in this document is subject to change without notice. While every effort has been made to eliminate errors, CommScope disclaims liability for any difficulties arising from the interpretation of the information contained herein. The information contained herein does not claim to cover all details or variations in equipment, nor to provide for every possible incident to be met in connection with installation, operation, or maintenance. This document describes the performance of the product under the defined operational conditions and does not cover the performance under adverse or disturbed conditions. Should further information be desired, or should particular problems arise which are not covered sufficiently for the purchaser's purposes, contact CommScope.

CommScope reserves the right to change all hardware and software characteristics without notice.

COPYRIGHT:

© Copyright 2018 CommScope Inc. All Rights Reserved.

This document is protected by copyright. No part of this document may be reproduced, stored in a retrieval system, or transmitted, in any form or by any means, electronic, mechanical photocopying, recording, or otherwise without the prior written permission of CommScope.

TRADEMARKS

All trademarks identified by ® or ™ are registered trademarks or trademarks, respectively, of CommScope. Names of products mentioned herein are used for identification purposes only and may be trademarks and / or registered trademarks of their respective companies.

Andrew Wireless Systems GmbH, 28-February-2018

TABLE OF CONTENTS

1. GENERAL	6
1.1. ABBREVIATIONS	6
1.2. HEALTH AND SAFETY	6
1.3. PROPERTY DAMAGE WARNINGS	7
1.4. COMPLIANCE	7
1.5. ABOUT COMMSCOPE	11
1.6. INTERNATIONAL CONTACT ADDRESSES FOR CUSTOMER SUPPORT	12
2. FUNCTIONAL DESCRIPTION	14
3. COMMISSIONING	15
3.1. GENERAL	15
3.2. ETHERNET CONNECTOR	16
3.3. INSERTING THE SIM CARD	17
3.3.1. External Modem of MR418	17
3.3.2. Internal Modem of MR418	17
4. INSTALLATION	18
4.1. MECHANICAL INSTALLATION	18
4.1.1. Property Damage Warnings for Mechanical Installation	18
4.1.2. Wall Mounting	18
4.1.3. Wall Mounting without Mounting Sheet	18
4.1.4. Wall Mounting the Modem to the MRx18 Single-Band / MR418	19
4.1.5. Wall Mounting the Modem to MRx18 Dual-Band and Dual/ Triple Segment with Mounting Sheet	19
4.1.5.1. Complete Equipment of Modem – LEFT side	20
4.1.5.2. Complete Equipment of Modem – RIGHT Side	21
4.1.5.3. Subsequent Upgrade of Modem – LEFT Side	22
4.1.5.4. Subsequent Upgrade of Modem – RIGHT side	23
4.2. ELECTRICAL INSTALLATION	24
4.2.1. General	24
4.2.2. Power Connection of External Modem with the MRx18	24
4.2.3. Power Connection of External Modem with the MR418	25
4.2.4. Power Connection of Internal Modem with the MR418	26
5. MODEM CONTROL AND REMOTE ACCESS VIA SMS	27
5.1. OPTIONAL ALARMING AND ADJUSTMENTS VIA SMS	27
5.2. SMS INTERFACE – COMMANDS AND NOTIFICATIONS	27

5.3.	SMS COMMANDS	28
5.3.1.	SET / GET Commands	29
5.3.1.1.	Config SMS	29
5.3.1.2.	Service Center Number	29
5.3.1.3.	Heartbeat Interval	30
5.3.1.4.	Alarm Severity	30
5.3.1.5.	Alarming Status	31
5.3.1.6.	Technical Setup (Settings - Radio Frequency)	31
5.3.1.7.	External Alarms (only MR418)	36
5.3.2.	GET-Only Commands	37
5.3.2.1.	Active Alarms	37
5.3.2.2.	RSSI	37
5.3.2.3.	Actual Gain and Output Power	38
5.3.2.4.	Cell Information	38
5.3.2.5.	Software Version	39
5.3.2.6.	Repeater Type (Model)	39
5.3.2.7.	Repeater Data	39
5.3.3.	SET-Only Command: Reboot	40
5.4.	NOTIFICATIONS	40
5.4.1.	Alarm	40
5.4.2.	Heartbeat	41
5.4.3.	System Startup	42
5.4.4.	System Configuration Changed	42
5.5.	REPEATER SETUP AND ALARMING VIA ETHERNET (WEBPAGES) – MODEM CONTROL	43
5.5.1.	Setup and Alarming via Ethernet (Webpages)	43
5.5.2.	Settings - Modem Control	44
5.5.3.	Maintenance - Modem Debugging	46
6.	MAINTENANCE	47
7.	APPENDIX	48
7.1.	SYSTEM SPECIFICATIONS	48
7.1.1.	Electrical Specifications	48
7.1.2.	Mechanical Specifications	48
7.1.3.	Environmental and Safety Specifications	48
7.2.	SPARE PARTS	48
8.	INDEX	49
9.	LIST OF CHANGES	50

FIGURES AND TABLES

figure 3-1 Ethernet connector of MRx18..... 16

figure 3-2 Ethernet connector of MR418..... 16

figure 3-3 Location of SIM card within external modem board..... 17

figure 3-4 SIM-card cover of internal modem..... 17

figure 3-5 SIM-card opening of internal modem..... 17

figure 4-1 Wall-mounting screws of modem..... 18

figure 4-2 Mounting the modem to the MRx18 Single-Band 19

figure 4-3 Modem with bracket and mounting sheet, left, complete equipment 20

figure 4-4 Modem mounted at left side of MRX18, complete equipment 20

figure 4-5 Modem with bracket and mounting sheet, right, complete equipment 21

figure 4-6 Modem mounted at right side of MRX18, complete equipment 21

figure 4-7 Mounting modem with bracket and mounting sheet, left, subsequent
upgrade..... 22

figure 4-8 Modem mounted at left side of MRX18, subsequent upgrade..... 22

figure 4-9 Modem with bracket and mounting sheet, right, subsequent upgrade..... 23

figure 4-10 Modem mounted at right side of MRX18, subsequent upgrade..... 23

figure 4-11 Power connection of modem kit with the MRx18 24

figure 4-12 Power connector of external modem 25

figure 4-13 Power connector of MR418 25

figure 4-14 Power connection of external modem with MR418..... 25

figure 4-15 Power connection of modem with MR418 26

figure 5-1 Modem Control, normal layout 44

figure 5-2 Maintenance - Modem Debugging, normal layout 46

table 5-1 Settings - Modem Control 45

table 5-2 Maintenance - Modem Debugging..... 46

1. General

1.1. Abbreviations

3GPP	3 rd Generation Partnership Project Channel	LED	Light Emitting Diode
		LMT	Local Maintenance Terminal
		LNA	Low Noise Amplifier
ALC	Automatic Level Control	MCC	Mobile Country Code
BCCH	Broadcast Control	MNC	Mobile Network Code
BITE	Built-In Test Equipment	MR	Microwave Repeater
BTS	Base Transceiver Station	MS	Mobile Station
CDMA	Code Division Multiple Access	OIP-3	Output Intercept Point of the 3rdOrder
CF	Center Frequency	OMC	Operation and Maintenance Center
CFO	Center Frequency Offset	PA	Power Amplifier
CFR	Code of Federal Regulations	PCS	Personal Communication System
DL	Downlink	PSTN	Public Switched Telephone Network
DoC	Declaration of Conformity	PSU	Power Supply Unit
EDGE	Enhanced Data Rates for GSM Evolution	RED	Radio Equipment Directive
ESD	Electrostatic Discharge	Rev	Revision
ETS	European Telecommunication Standard	RF	Radio Frequency
ETSI	European Telecommunication Standards Institute	RoHS	Directive on Restriction of certain Hazardous Substances
GSM	Global System for Mobile Communication	RLP	Radio Link Protocol
GUI	Graphical User Interface	RSSI	Receive Signal Strength Indication
I2C-Bus	Inter-Integrated Circuit Bus (Philips)	RTC	Real-Time Clock
ID No	Identification Number	RX	Receiver
IF	Intermediate Frequency	SCL	Serial Clock
ISDE	Innovation, Sciences et Développement économique Canada	SDA	Serial Data
ISED	Innovation, Science and Economic Development Canada; formerly IC / Industry Canada	SMSC	Short Message Service Center
		TCH	Traffic Channel
		TDMA	Time Division Multiple Access
		TX	Transmitter
		UE	User Equipment
		UL	Uplink
		UMTS	Universal Mobile Telecommunication System
		UPS	Uninterruptable Power Supply
		URL	Uniform Resource Locutor

1.2. Health and Safety



- 1. Caution:** High frequency radiation in operation. Risk of health hazards associated with radiation from the antenna(s) connected to the unit. Implement prevention measures to avoid the possibility of very close proximity to the antenna(s) while in operation.

1.3. Property Damage Warnings

1. **Attention:** Due to power dissipation, the unit may reach a high temperature. Do not operate this equipment on or close to flammable materials. Use caution when servicing the unit.
2. **Notice:** ESD precautions must be observed. Before commencing maintenance work, use the available grounding (earthing) system to connect ESD protection measures.
3. **Notice:** Only suitably qualified personnel are allowed to work on this unit and only after becoming familiar with all safety notices, installation, operation and maintenance procedures contained in this manual.
4. **Notice:** Keep operating instructions within easy reach and make them available to all users.



1.4. Compliance

1. **Notice:** For installations, which have to comply with FCC RF exposure requirements, the antenna selection and installation must be completed in a way to ensure compliance with those FCC requirements. Depending on the RF frequency, rated output power, antenna gain, and the loss between the repeater and antenna, the minimum distance D to be maintained between the antenna location and human beings is calculated according to this formula:

$$D_{[cm]} = \sqrt{\frac{P_{[mW]}}{4 * \pi * PD_{[mW/cm^2]}}}$$

where

- P (mW) is the radiated power at the antenna, i.e. the max. rated repeater output power in addition to the antenna gain minus the loss between the repeater and the antenna.
- PD (mW/cm²) is the allowed Power Density limit acc. to 47 CFR 1.1310 (B) for general population / uncontrolled exposures which is
 - F (MHz) / 1500 for frequencies from 300MHz to 1500MHz
 - 1 for frequencies from 1500MHz to 100,000MHz

RF exposure compliance may need to be addressed at the time of licensing, as required by the responsible FCC Bureau(s), including antenna co-location requirements of 1.1307(b)(3).

2. **Notice:** For installations which have to comply with European EN50385 exposure compliance requirements, the following Power Density limits/guidelines (mW/cm²) according to ICNIRP are valid:
 - 0.2 for frequencies from 10 MHz to 400 MHz
 - F (MHz) / 2000 for frequencies from 400 MHz to 2 GHz
 - 1 for frequencies from 2 GHz to 300 GHz

3. Notice: For installations which have to comply with FCC/ISED requirements:**English:**

This device complies with FCC Part 15 and Industry Canada license exempt RSS standard(s). Operation is subject to the following two conditions: (1) this device may not cause interference, and (2) this device must accept any interference, including interference that may cause undesired operation of the device.

This device complies with Health Canada's Safety Code. The installer of this device should ensure that RF radiation is not emitted in excess of the Health Canada's requirement. Information can be obtained at http://www.hc-sc.gc.ca/ewh-semt/pubs/radiation/radio_guide-lignes_direct-eng.php.

Changes or modifications not expressly approved by the party responsible for compliance could void the user's authority to operate the equipment.

Antenna Stmt for ISED:

This device has been designated to operate with the antennas having a maximum gain of 9 dBi. Antennas having a gain greater than 9 dBi are prohibited for use with this device without consent by ISED regulators. The required antenna impedance is 50 ohms.

The antenna(s) used for this transmitter must be installed to provide a separation distance of at least 100 cm from all persons and must not be co-located or operating in conjunction with any other antenna or transmitter. Users and installers must be provided with antenna installation instructions and transmitter operating conditions for satisfying RF exposure compliance.

French:

Cet appareil est conforme à FCC Partie 15. Son utilisation est soumise à Les deux conditions suivantes: (1) cet appareil ne peut pas provoquer d'interférences et (2) cet appareil doit accepter Toute interférence, y compris les interférences qui peuvent causer un mauvais fonctionnement du dispositif.

Cet appareil est conforme avec Santé Canada Code de sécurité 6. Le programme d'installation de cet appareil doit s'assurer que les rayonnements RF n'est pas émis au-delà de l'exigence de Santé Canada. Les informations peuvent être obtenues: http://www.hc-sc.gc.ca/ewh-semt/pubs/radiation/radio_guide-lignes_direct-fra.php

Les changements ou modifications non expressément approuvés par la partie responsable de la conformité pourraient annuler l'autorité de l'utilisateur à utiliser cet équipement.

Antenne Stmt pour ISDE:

Ce dispositif a été désigné pour fonctionner avec les antennes ayant un gain maximal de 9 dBi. Antennes ayant un gain plus grand que 9 dBi sont interdites pour une utilisation avec cet appareil sans le consentement des organismes de réglementation d'ISDE. L'impédance d'antenne requise est 50 ohms.

L'antenne (s) utilisé pour cet émetteur doit être installé pour fournir une distance de séparation d'au moins 100 cm de toutes les personnes et ne doit pas être co-localisées ou opérant en conjonction avec une autre antenne ou émetteur. Les utilisateurs et les installateurs doivent être fournis avec des instructions d'installation de l'antenne et des conditions de fonctionnement de l'émetteur pour satisfaire la conformité aux expositions RF.

4. **Notice:** Installation of this equipment is in full responsibility of the installer, who has also the responsibility, that cables and couplers are calculated into the maximum gain of the antennas, so that this value, which is filed in the FCC Grant and can be requested from the FCC data base, is not exceeded. The industrial boosters are shipped only as a naked booster without any installation devices or antennas as it needs for professional installation.
5. **Notice:** Corresponding local particularities and regulations must be observed. For national deviations, please refer to the respective documents that can be downloaded as well.
6. **Notice:** The power supply of the unit complies with Overvoltage Category II. It also complies with the surge requirement according to EN 61000-4-5 (fine protection); however, installation of an additional medium (via local supply connection) and/or coarse protection (external surge protection) is recommended depending on the individual application in order to avoid damage caused by overcurrent.

For Canada and US, components used to reduce the Overvoltage Category shall comply with the requirements of IEC 61643-series. As an alternative, components used to reduce the Overvoltage Category may comply with ANSI/IEEE C62.11, CSA Certification Notice No. 516, CSA C22.2 No. 1, or UL 1449. Suitability of the component for the application shall be determined for the intended installation.

7. **Note:** For a Class A digital device or peripheral:

This equipment has been tested and found to comply with the limits for a Class A digital device, pursuant to part 15 of the FCC Rules. These limits are designed to provide reasonable protection against harmful interference when the equipment is operated in a commercial environment. This equipment generates, uses, and can radiate radio frequency energy and, if not installed and used in accordance with the instruction manual, may cause harmful interference to radio communications. Operation of this equipment in a residential area is likely to cause harmful interference in which case the user will be required to correct the interference at his own expense.

8. **Note:** For a Class B digital device or peripheral:

This equipment has been tested and found to comply with the limits for a Class B digital device, pursuant to part 15 of the FCC Rules. These limits are designed to provide reasonable protection against harmful interference in a residential installation. This equipment generates, uses and can radiate radio frequency energy and, if not installed and used in accordance with the instructions, may cause harmful interference to radio communications. However, there is no guarantee that interference will not occur in a particular installation. If this equipment does cause harmful interference to radio or television reception, which can be determined by turning the equipment off and on, the user is encouraged to try to correct the interference.

9. **Note:** This unit complies with European standard EN60950-1 / EN62368-1.

Equipment Symbols Used / Compliance

Please observe the meanings of the following symbols used in our equipment and the compliance warnings:

Symbol	Compliance	Meaning / Warning
---	FCC	For industrial (Part 20) signal booster: WARNING: This is NOT a CONSUMER device. It is designed for installation by FCC LICENSEES and QUALIFIED INSTALLERS. You MUST have an FCC LICENSE or express consent of an FCC Licensee to operate this device. Unauthorized use may result in significant forfeiture penalties, including penalties in excess of \$100,000 for each continuing violation.
		For (Part 90) signal booster: WARNING: This is NOT a CONSUMER device. It is designed for installation by FCC LICENSEES and QUALIFIED INSTALLERS. You MUST have an FCC LICENSE or express consent of an FCC Licensee to operate this device. You MUST register Class B signal boosters (as defined in 47 CFR 90.219) online at www.fcc.gov/signal-boosters/registration . Unauthorized use may result in significant forfeiture penalties, including penalties in excess of \$100,000 for each continuing violation.
---	ISED	WARNING: This is NOT a CONSUMER device. It is designed for installation by an installer approved by an ISED licensee. You MUST have an ISED LICENCE or the express consent of an ISED licensee to operate this device. AVERTISSEMENT: Ce produit N'EST PAS un appareil de CONSOMMATION. Il est conçu pour être installé par un installateur approuvé par un titulaire de licence d'ISDE. Pour utiliser cet appareil, vous DEVEZ détenir une LICENCE d'ISDE ou avoir obtenu le consentement exprès d'un titulaire de licence autorisé par ISDE.
CE	CE	To be sold exclusively to mobile operators or authorized installers – no harmonized frequency bands, operation requires license. Intended use: EU and EFTA countries
		Indicates conformity with the RED directive 2014/53/EU and/or RoHS directive 2011/65/EU.
CE 0700	CE	Indicates conformity with the RED directive 2014/53/EU and RoHS directive 2011/65/EU certified by the notified body no. 0700.

1.5. About CommScope

CommScope is the foremost supplier of one-stop, end-to-end radio frequency (RF) solutions. Part of the *CommScope* portfolio are complete solutions for wireless infrastructure from top-of-the-tower base station antennas to cable systems and cabinets, RF site solutions, signal distribution, and network optimization. For patents see www.cs-pat.com.

CommScope has global engineering and manufacturing facilities. In addition, it maintains field engineering offices throughout the world.

Andrew Wireless Systems GmbH based in Buchdorf/ Germany, which is part of *CommScope*, is a leading manufacturer of coverage equipment for mobile radio networks, specializing in high performance, RF and optical repeaters. Our optical distributed networks and RF repeater systems provide coverage and capacity solution for wireless networks in both indoor installations and outdoor environments, e.g. tunnels, subways, in-trains, airport buildings, stadiums, skyscrapers, shopping malls, hotels and conference rooms.

Andrew Wireless Systems GmbH operates a quality management system in compliance with the requirements of ISO 9001 and TL 9000. All equipment is manufactured using highly reliable material. To maintain highest quality of the products, comprehensive quality monitoring is conducted at all fabrication stages. Finished products leave the factory only after a thorough final acceptance test, accompanied by a test certificate guaranteeing optimal operation.

Hereby Andrew Wireless Systems declares that the radio equipment type Repeater is in compliance with Directive 2014/53/EU.

The full text of the EU declaration is available at the following internet address: www.commscope.com/collateral/Declarations_of_Conformity/.

According to the DoC, our “CE”-marked equipment can be used in all member states of the European Union.

Note: Exceptions of and national deviations from this intended use may be possible. To observe corresponding local particularities and regulations, please refer to the respective documents (also in national language) which can be downloaded as well.

To make the most of this product, we recommend you carefully read the instructions in this manual and commission the system only according to these instructions.

For technical assistance and support, please also contact the local office or *CommScope* directly at one of the addresses listed in the following chapter.

1.6. International Contact Addresses for Customer Support

Canada		United States
CommScope Canada		Andrew LLC, A CommScope Company
Mail 505 Consumers Road, Suite 803 Toronto M2J 4V8, Canada		Mail 620 North Greenfield Parkway Garner, NC 27529, U.S.A.
Phone +1-905-878-3457 (Office) +1-416-721-5058 (Cell)	A M E R I C A S	Phone +1-888-297-6433
Fax +1-905-878-3297		Fax +1-919-329-8950
E-mail wisupport@commscope.com		E-mail wisupport@commscope.com
Caribbean & South American Region		Caribbean & Central American Region
CommScope Cabos do Brasil Ltda.		CommScope Mexico S.A. de C.V.
Mail CALA Tech Support for <i>Distributed Coverage & Capacity Solutions (DCCS) products:</i> Rua Guaporanga, 49 Praça Seca – Rio de Janeiro – RJ ZIP: 21320-180, Brazil		Mail CALA Tech Support for <i>Distributed Coverage & Capacity Solutions (DCCS) products:</i> Av. Insurgentes Sur 688, Piso 6 Col. Del Valle, CP: 03100 Mexico City, Mexico
Phone +1-815-546-7154 (Cell) +55-15-9104-7722 (Office)		Phone +52-55-1346-1900 (Office)
Fax + 55-15-2102-4001		Fax +52-55-1346-1901
E-mail wisupport@commscope.com		E-mail wisupport@commscope.com
China, India and Rest of Asia		Australia & New Zealand
Andrew International Corporation		Andrew Corporation (Australia) Pty Ltd.
Mail Room 915, 9/F Chevalier Commercial Centre 8 Wang Hoi Rd Kowloon Bay, Hong Kong	A P A C	Mail Unit 1 153 Barry Road Campbellfield VIC 3061, Australia
Phone +852-3106-6100		Phone +613-9300-7969
Fax +852-2751-7800		Fax +613-9357-9110
E-mail wisupport.China@commscope.com		E-mail wisupport.Australia@commscope.com
Middle East & North Africa		South Africa
CommScope Solutions International Inc. (Branch)		Andrew Wireless Solutions Africa (PTY) LTD
Mail PO Box 48 78 22 Unit 3206, Floor 32, Jumeirah Business Center 5, Jumeirah Lakes Towers, Dubai, United Arab Emirates	Africa & Middle East	Mail 11 Commerce Crescent West Eastgate, Sandton PO Box 786117 Sandton 2146 South Africa
Phone +971 4 390 09 80		Phone + 27 11-719-6000
Fax +971 4 390 86 23		Fax + 27 11-444-5393
E-mail wisupport@commscope.com		E-mail wisupport@commscope.com

United Kingdom		E U R O P E	Scandinavia	
Andrew Wireless Systems UK Ltd			Andrew Norway (AMNW)	
Mail	Unit 15, Ilex Building Mulberry Business Park Fishponds Road Wokingham Berkshire RG41 2GY, England		Mail	P.O. Box 3066 Osloveien 10 Hoenefoss 3501 Norway
Phone	+44-1189-366-792		Phone	+ 47 32-12-3530
Fax	+44-1189-366-773		Fax	+ 47 32-12-3531
E-mail	wisupport.uk@commscope.com		E-mail	wisupport@commscope.com
Germany			France	
Andrew Wireless Systems GmbH			CommScope France	
Mail	Industriering 10 86675 Buchdorf Germany		Mail	Immeuble Le Lavoisier 4, Place des Vosges 92052 Courbevoie, France
Phone	+49-9099-69-0		Phone	+33-1 82 97 04 00
Fax	+49-9099-69-930	Fax	+33-1 47 89 45 25	
E-mail	wisupport@commscope.com	E-mail	wisupport@commscope.com	
Austria		Switzerland		
Andrew Wireless Systems (Austria) GmbH		CommScope Wireless Systems AG		
Mail	Weglgasse 10 2320 Wien-Schwechat Austria	Mail	Tiergartenweg 1 CH-4710 Balsthal Switzerland	
Phone	+43-1706-39-99-10	Phone	+41-62-386-1260	
Fax	+43-1706-39-99-9	Fax	+41-62-386-1261	
E-mail	wisupport.austria@commscope.com	E-mail	wisupport.ch@commscope.com	
Italy		Iberia Region - Spain & Portugal		
CommScope Italy S.r.l., Faenza, Italy		Andrew España S.A. A CommScope Company		
Mail	Via Mengolina, 20 48018 Faenza (RA) Italy	Mail	Avda. de Europa, 4 - 2ª pta. Parque Empresarial de la Moraleja Alcobendas, Madrid 28108, Spain	
Phone	+39-0546-697111	Phone	+34-91-745-20 40	
Fax	+39-0546-682768	Fax	+34-91-661-87 02	
E-mail	wisupport.italia@commscope.com	E-mail	wisupport.iberia@commscope.com	
Czech Republic				
CommScope Solutions Czech Republic C-Com, spol. s r.o				
Mail	U Moruší 888 53006 Pardubice, Czech Republic			
Phone	+49 871 9659171 (Office) +49 171 4001166 (Mobile)			
Fax	+49 871 9659172			
E-mail	wisupport@commscope.com			

2. Functional Description

Modem for MRx18 Remote Monitoring Option – SMS

Remote Control and Alarm Monitoring Option via GSM-SMS for MRx18 miniRepeater

The Modem for MRx18 Remote Monitoring Option – SMS is a cost-effective solution for monitoring MRx18 miniRepeater remotely and gives designers a simple tool to forward alarms via GSM SMSs and to change parameters of the MRx18 miniRepeater.

The MRx18 Remote Monitoring Option only requires an additional modem kit consisting of a modem and cables. The modem is supplied by the MRx18, thus, no additional PSU is needed. Apart from the MR418, all MRx18 are equipped with an internal coupler, therefore no external coupler is required. The antenna port of the modem is simply connected to the coupling port of the MRx18, so RF signals to/from the modem are received/ transmitted at the donor antenna port of the MRx18.

Depending on the configuration, the MR418 may optionally be equipped with an internal modem. The modem antenna is connected to a separate port at the MR418; there is no common antenna port for donor antenna of the repeater and antenna for the modem. Beside the internal modem, also this external modem that is designed for the MRx18 repeaters can be utilized for the MR418. In this case the antenna for the modem has to be connected to the modem RF port. Commands and behavior of the internal modem are identical to the ones of the external modem. Deviations from the commands for the MR418 compared to the commands for MRx18 repeaters in general, are stated in this manual.

The modem provides remote supervision via SMS in GSM850 GSM900, GSM1800, and GSM1900 mobile networks.

In case an alarm occurs, an alarm SMS is forwarded to a SMS receiver (e.g. a mobile phone) or to A.I.M.O.S.

A heartbeat SMS is sent at certain time intervals in order to inform whether the system is in operation. Furthermore parameters/settings of the MRx18 can be changed via SMS commands or A.I.M.O.S.; status information of the MRx18 can be queried, too.

The monitoring via SMS can be easily commissioned via web-pages of the MRx18 or via a configuration SMS sent from A.I.M.O.S. or e.g. a mobile phone.

Features:

- Easy installation due to light weight and small dimensions
- Smart design
- Commissioning via MRx18 web pages
- No additional external DC converters necessary
- Alarming (including heartbeat)
- Modification of MRx18 settings
- Query of MRx18 status
- Support of A.I.M.O.S.

3. Commissioning

3.1. General

Read and observe chapter 1.2.

Note: The electrical installation has to be performed in accordance with the safety regulations of the local authorities. Due to safety reasons, the electrical installation must be performed by qualified personnel only. The repeater must not be opened.

The following installation steps must be carried out to commission the modem:

1. Insert the SIM card into the drawer (as described in chapter 3.3 Inserting the SIM Card).
2. Provide connection of modem kit with miniRepeater MRx18 (as described in chapter 4.2 Electrical Installation).
3. Mount miniRepeater and modem kit to a wall (see chapter 4.1 Mechanical Installation)
4. Connect miniRepeater to mains.
5. Configure modem via Ethernet webpage – Modem Control Page (as described in chapter 5.5) or via config SMS and SMS commands (see chapter 5.3.1 SET / GET Commands). The external modem is initialized during the boot process; the internal modem of the MR418 * has to be selected manually in the Modem Control page.

When an external modem is connected to the MR418 with internal modem, the external modem is activated during the boot process, even if the internal modem has been selected before. Hence, the internal modem will be disabled after the boot process.

* This modem type has been discontinued and is no longer available.

3.2. Ethernet Connector

The Ethernet connector is used to configure the entire modem settings via the *Modem Control* webpage (as described in chapter 5.5. Locally, the web pages are accessible via the Ethernet connector (as described in the MRx18 manual).

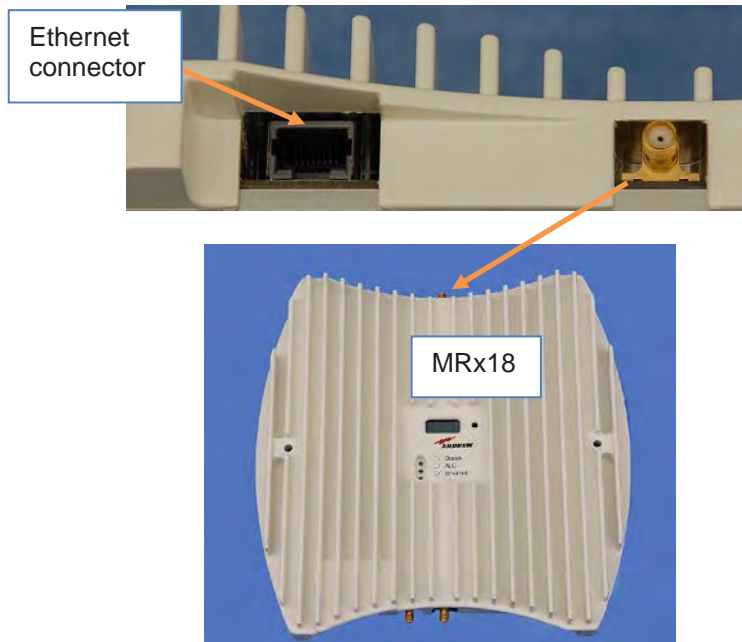

figure 3-1 Ethernet connector of MRx18

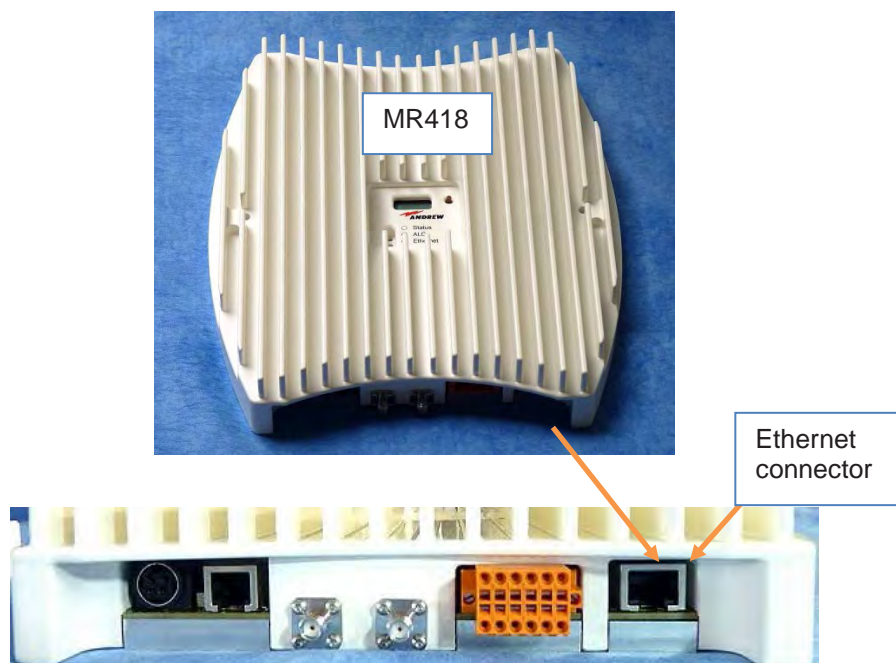

figure 3-2 Ethernet connector of MR418

3.3. Inserting the SIM Card

3.3.1. External Modem of MR418

In order to insert the SIM card, the modem has to be opened. To prevent the SIM card from abuse and theft, it is hidden inside the modem. In order to access the SIM-card drawer proceed as follows:

- Remove the modem from the mounting sheet by opening the metric M3x12 tallow-drop torx screws.
- Remove the cover at the rear side of the modem.
- Insert the SIM card into the drawer.
- Close the cover and fasten the modem to the mounting sheet again.

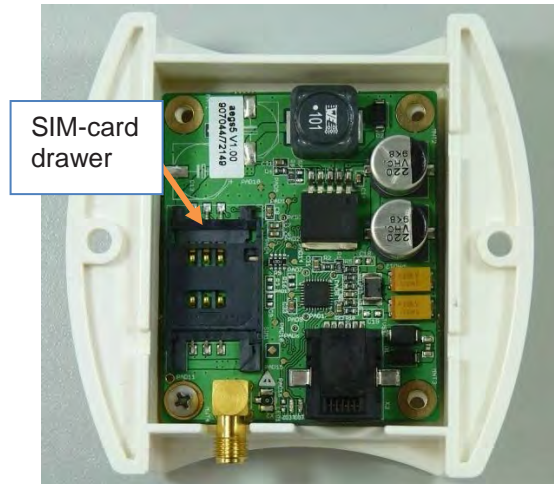

figure 3-3 Location of SIM card within external modem board

3.3.2. Internal Modem of MR418

Note: This modem type has been discontinued and is no longer available.

The SIM card is protected by a black plastic cover. Remove the plastic cover to get access to the SIM-card drawer.



figure 3-4 SIM-card cover of internal modem

Use a pen or any other appropriate tool to press on the yellow button and open the drawer. After insertion, push onto the drawer carefully and remount the plastic cover.

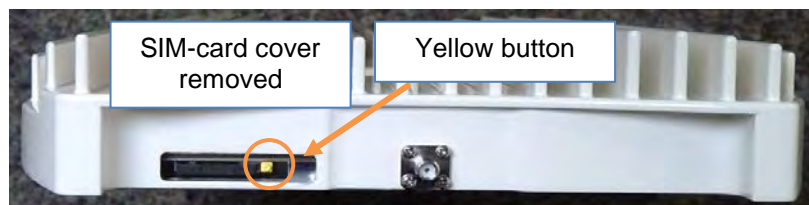

figure 3-5 SIM-card opening of internal modem

4. Installation

4.1. Mechanical Installation

4.1.1. Property Damage Warnings for Mechanical Installation

1. **Attention:** Do not install the unit in a way or at a place where the specifications outlined in the Environmental and Safety Specifications leaflet of the supplier are not met.
2. **Attention:** It is the responsibility of the installer to verify that the supporting surface will safely support the combined load of the electronic equipment and all attached hardware and components and to ensure that the unit is safely and securely mounted.
3. **Notice:** Use proper mounting hardware depending on the structure of e.g. the wall where the unit will be installed.

4.1.2. Wall Mounting

The MRx18 modem kit is designed for wall mounting or for mounting by using the mounting sheet delivered with the modem.

Note: Wall-mounting screws are NOT equipped / included in the modem kit delivery. The requirements for these screws depend on the wall where the modem will be mounted.

4.1.3. Wall Mounting without Mounting Sheet

The following figures show a schematic view of the MRx18 including modem kit. Slight variations in design compared to the unit illustrated are possible.

Note: Before mounting the modem to the wall, insert the SIM card as described in chapter 3.3.1 *External Modem of MR418*.

Mount the MRx18 modem kit **horizontally** to the wall with two screws (circle-marked in picture to the right) suitable for your wall.

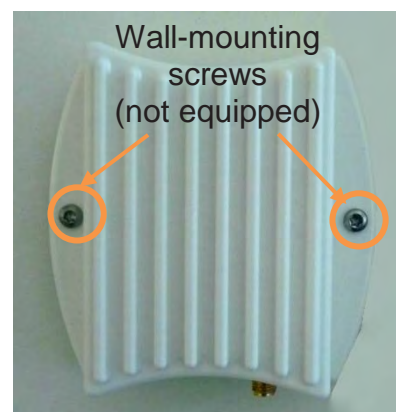

figure 4-1 Wall-mounting screws of modem

The position of the modem has to be chosen depending on the length of the cables (approx. 350 mm) that have to be installed between modem and miniRepeater. For the flat and RF cables that must be installed between modem kit and MRx18 please see chapter 4.2.2 Power Connection of External Modem with the MRx18.

4.1.4. Wall Mounting the Modem to the MRx18 Single-Band / MR418

Note: Before mounting the modem to the wall, insert the SIM card as described in chapter 3.3.1 *External Modem of MR418*.

Select whether to mount the modem to the left or to the right side of the MRx18 Single-Band and/or MR418. Both mounting positions are possible.

To mount the modem to the MRx18 / MR418, loosen the screws by which the MRx18 is fastened to the wall slightly so that the bracket of the modem can be inserted. Tighten the fastening screws of the MRx18 again.

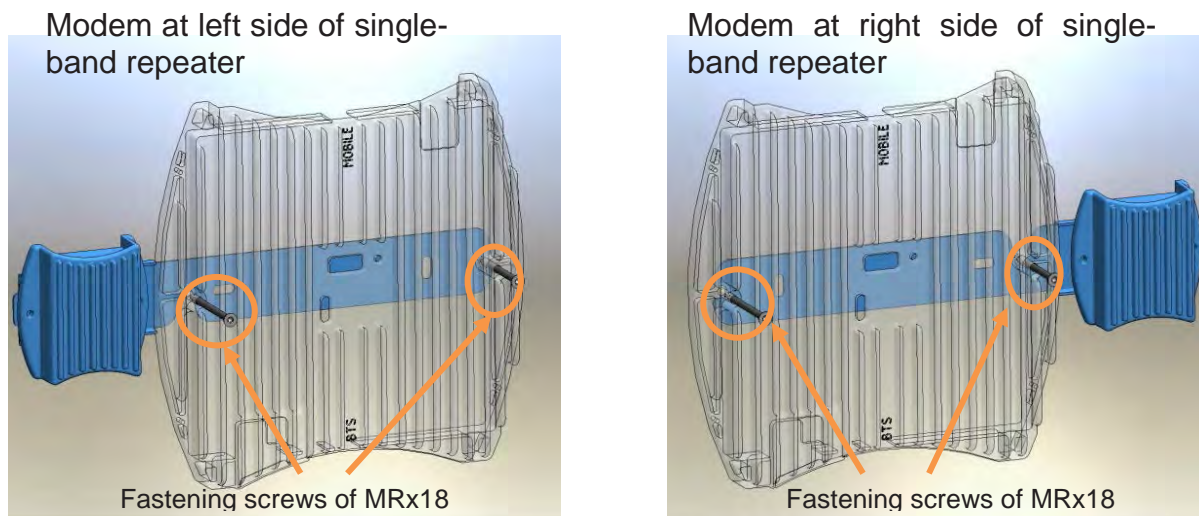

figure 4-2 Mounting the modem to the MRx18 Single-Band

4.1.5. Wall Mounting the Modem to MRx18 Dual-Band and Dual/ Triple Segment with Mounting Sheet

Note: Before mounting the modem to the wall, insert the SIM card as described in chapter 3.3.1 *External Modem of MR418*.

Note: The following mounting descriptions distinguish between complete equipment of the Modem Kit & miniRepeater (i.e. the miniRepeater and the external modem kit together are part of a new complete equipment) and subsequent modem upgrade (i.e. the repeater has already been delivered without the modem, and the modem has to be additionally mounted afterwards).

Note: The modem can be located and mounted to the left or right side of the mounting sheet. As delivered, the modem is pre-mounted for wall mounting on the LEFT side.

4.1.5.1. Complete Equipment of Modem – LEFT side

Hang in the modem together with the pre-mounted bracket to the repeater mounting sheet according to the following illustrations.

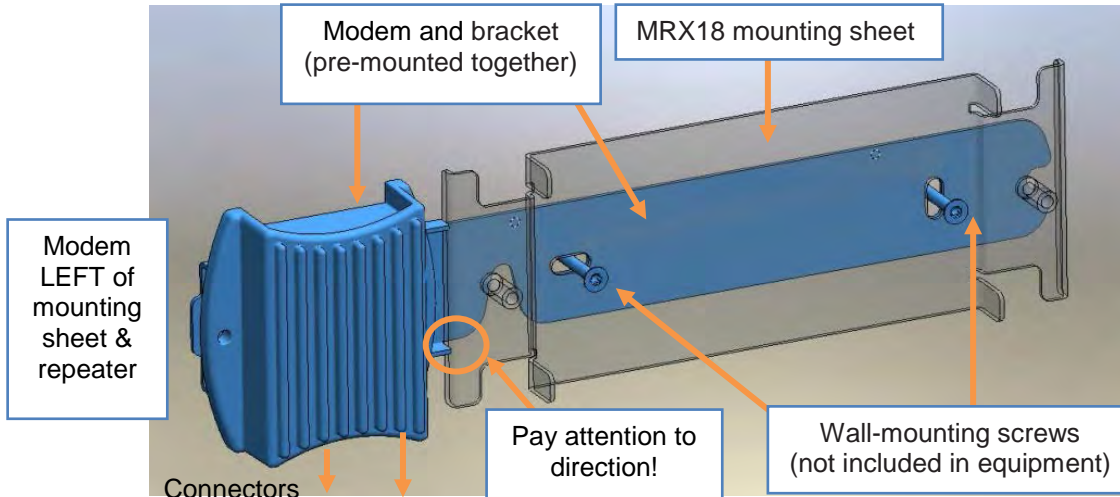

figure 4-3 Modem with bracket and mounting sheet, left, complete equipment

When mounted correctly, it should look like this:

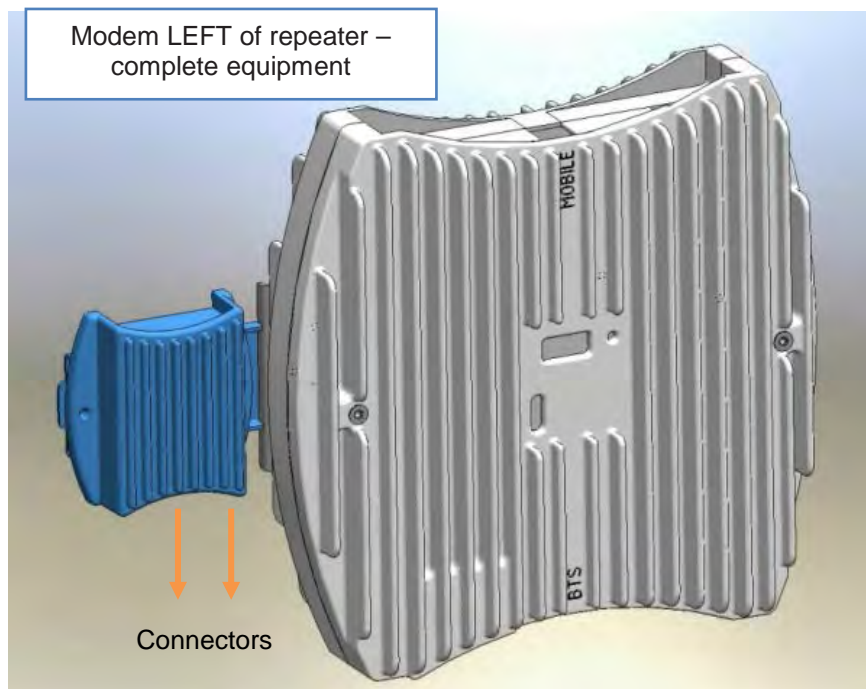

figure 4-4 Modem mounted at left side of MRX18, complete equipment

4.1.5.2. Complete Equipment of Modem – RIGHT Side

Should wall-mounting of the modem on the right side be required, proceed as follows:

Loosen the modem from the pre-mounted bracket, turn the modem around by 180° to the right and reverse the fastening screws.

Note: The connectors of the modem must point to the ground!

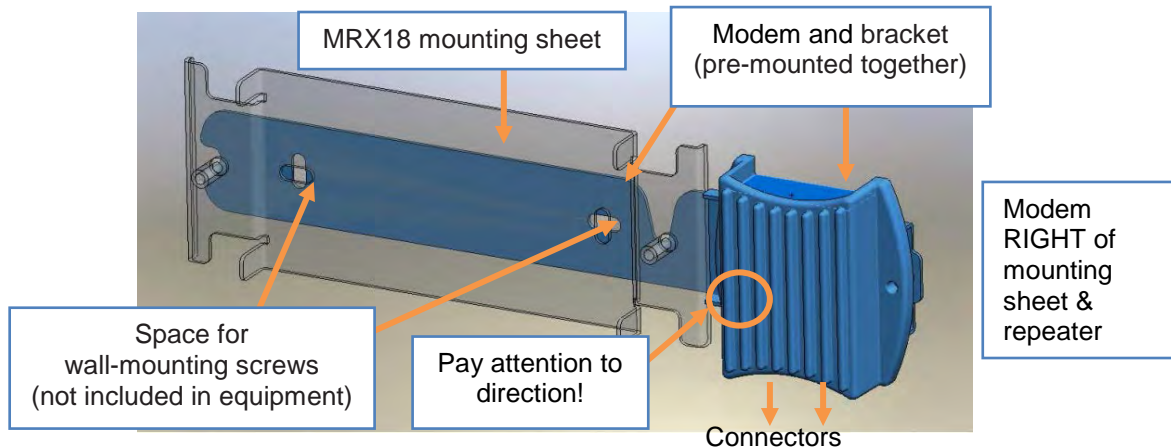

figure 4-5 Modem with bracket and mounting sheet, right, complete equipment

When mounted correctly, it should look like this:

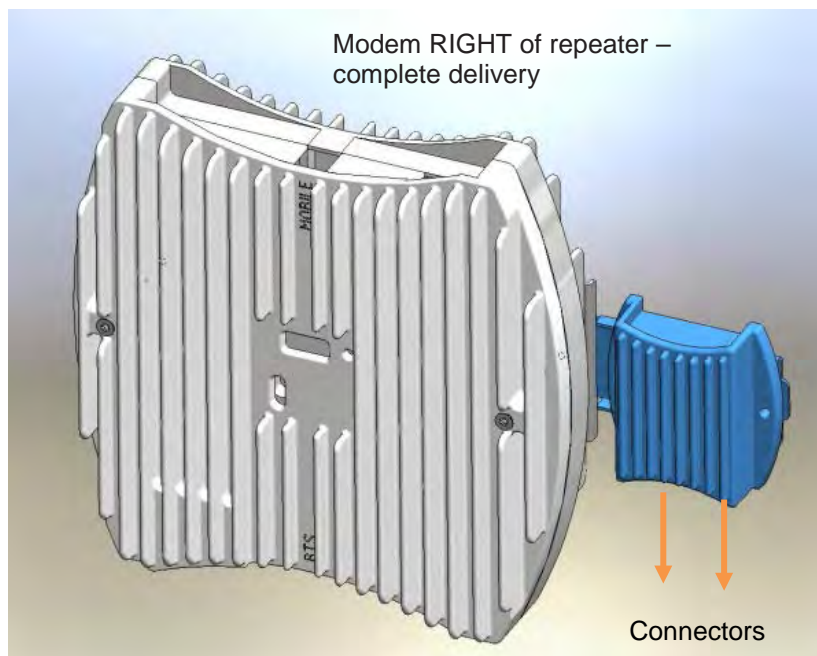

figure 4-6 Modem mounted at right side of MRX18, complete equipment

4.1.5.3. Subsequent Upgrade of Modem – LEFT Side

When the mounting bracket of the dual-band repeater has already been fastened to the wall, then proceed as follows:

Unscrew the repeater with the metric screws off the bracket, fasten the modem bracket to the mounting sheet and fasten the repeater again to the bracket and wall.

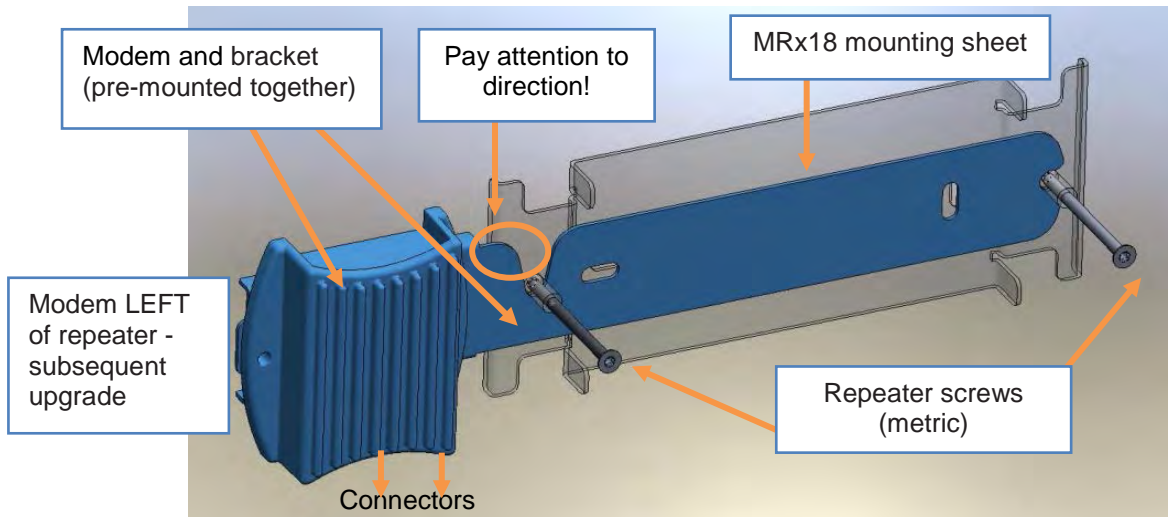

figure 4-7 Mounting modem with bracket and mounting sheet, left, subsequent upgrade

Screw the modem with the bracket together exactly as shown in the picture above. When mounted correctly, it should look like this:

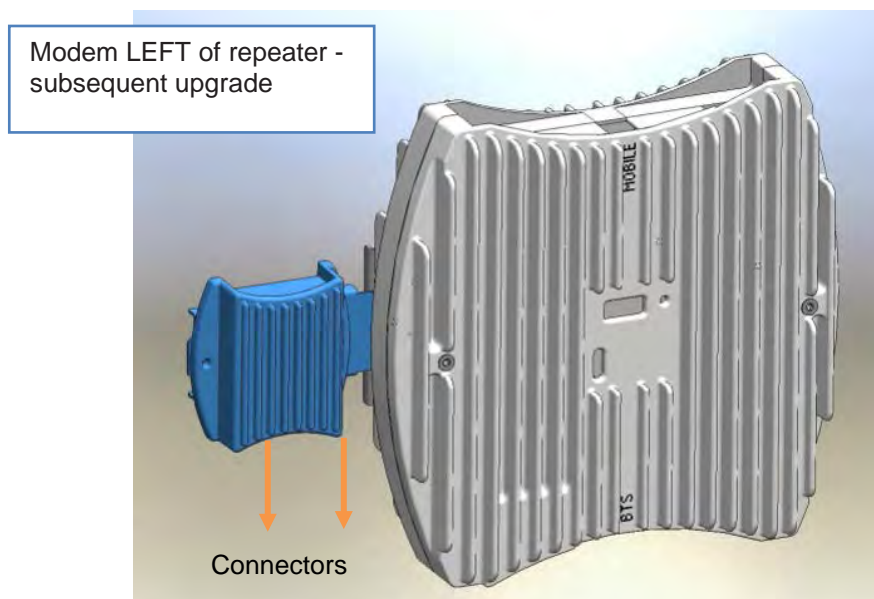

figure 4-8 Modem mounted at left side of MRX18, subsequent upgrade

4.1.5.4. Subsequent Upgrade of Modem – RIGHT side

Should wall-mounting of the modem on the right side be required, proceed as follows:

Loosen the modem from the pre-mounted bracket, turn the modem around by 180° to the right and reverse the fastening screws.

Note: The connectors of the modem must point to the ground!

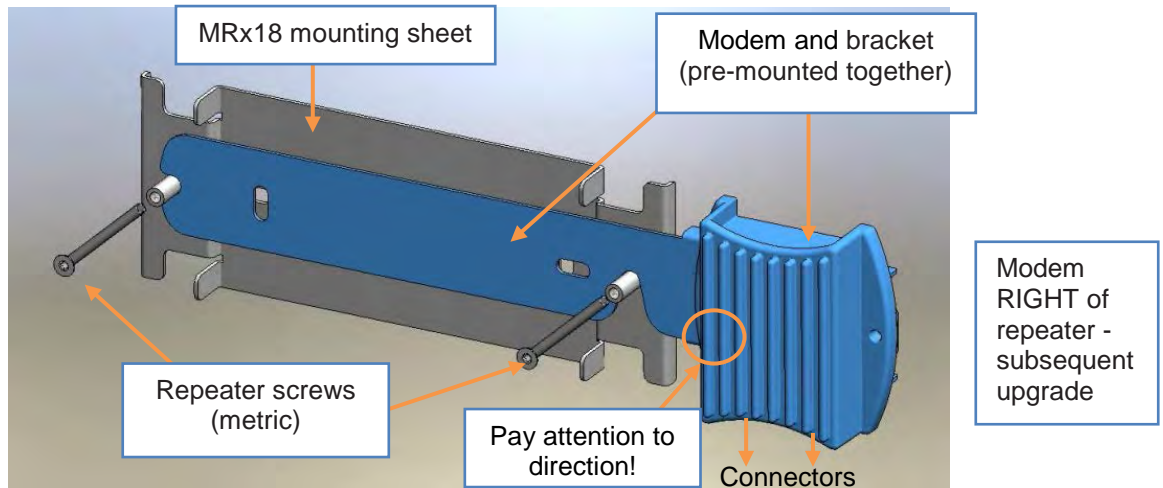

figure 4-9 Modem with bracket and mounting sheet, right, subsequent upgrade

Screw the modem with the bracket together exactly as shown in the picture above. When mounted correctly, it should look like this:

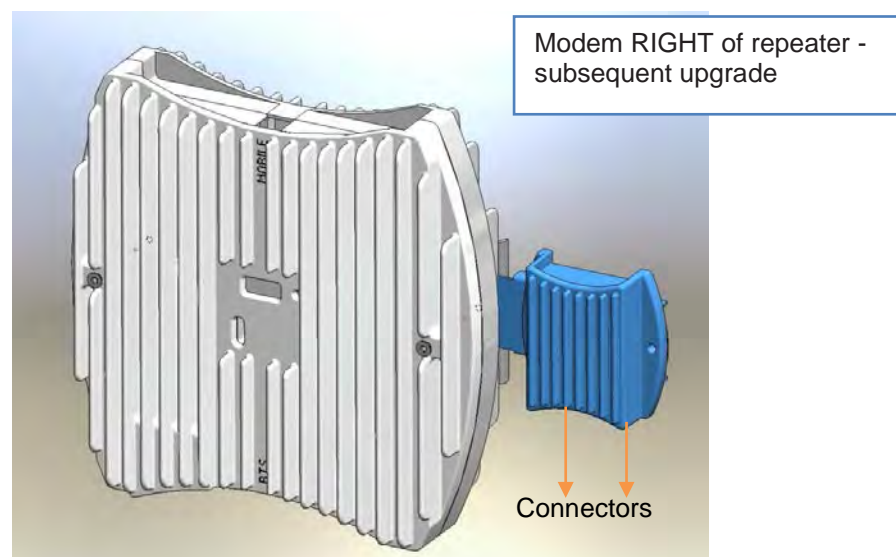

figure 4-10 Modem mounted at right side of MRX18, subsequent upgrade

4.2. Electrical Installation

4.2.1. General

1. **Notice:** The electrical installation has to be performed in accordance with the safety regulations of the local authorities. Due to safety reasons, the electrical installation must be performed by qualified personnel only. The repeater must not be opened.
2. **Notice:** Observe the labels on the front panels before connecting or disconnecting any cables.

4.2.2. Power Connection of External Modem with the MRx18

The modem is entirely supplied with power from the MRx18 via the flat cable. For power connection, connect the flat cable to the MRx18 Molex connector (6 poles) provided for the modem.

For RF connection, connect the RF cable from the RF connector at the modem to the SMA connector at the MRx18 (designated as "SMA RF connector for modem coupler" in the illustration below).

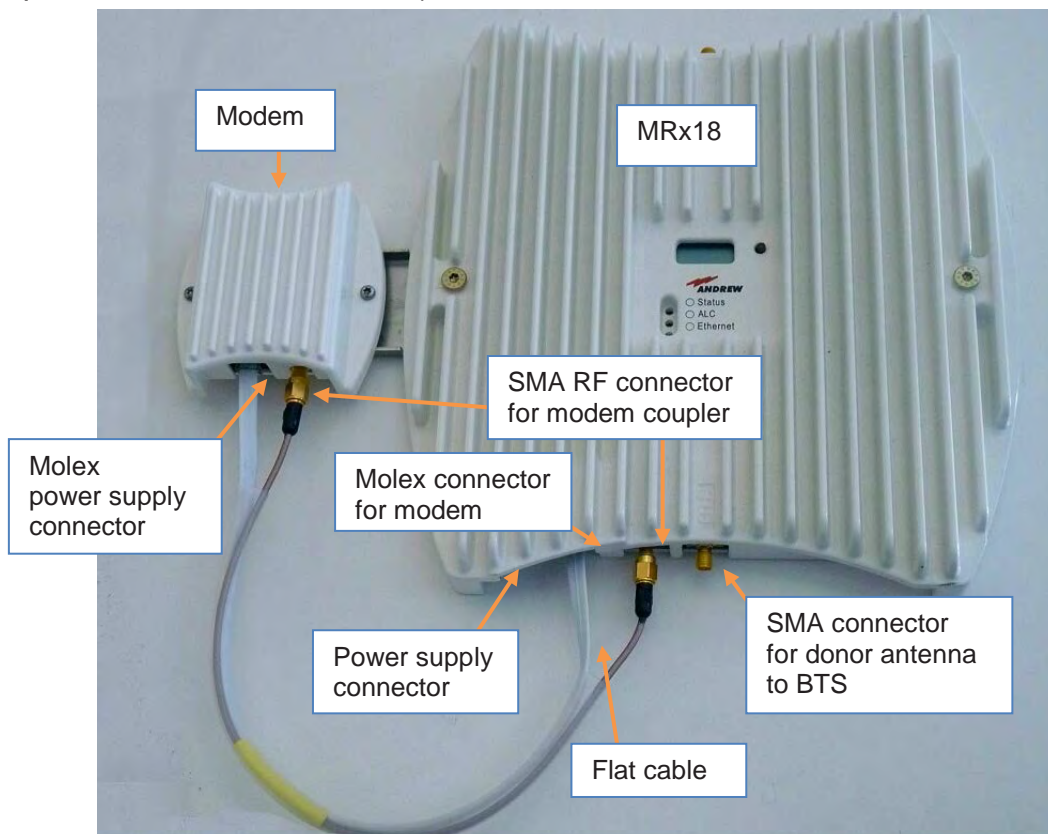

figure 4-11 Power connection of modem kit with the MRx18

The minimum level at the modem antenna port has to be > -100 dBm for proper operation.

Note: For MRx18, the coupling loss of the modem coupler integrated to the MRx18 repeater is approx. -25 dB. Thus, the minimum level at the BTS port of the repeater has to be > -75 dBm. However, this does not apply to the MR418.

4.2.3. Power Connection of External Modem with the MR418

The modem is entirely supplied with power from the MR418 via the flat cable. For power connection, connect the flat cable to the MR418 Molex connector (6 poles) provided for the modem.

Connect the antenna for the modem to the RF port of the modem; the MR418 is not equipped with a modem coupler. The RF cable, part of the cable harness delivered, is not needed for this application. If a common antenna for repeater and modem is installed, the signals have to be combined via an external coupler.



figure 4-12 Power connector of external modem

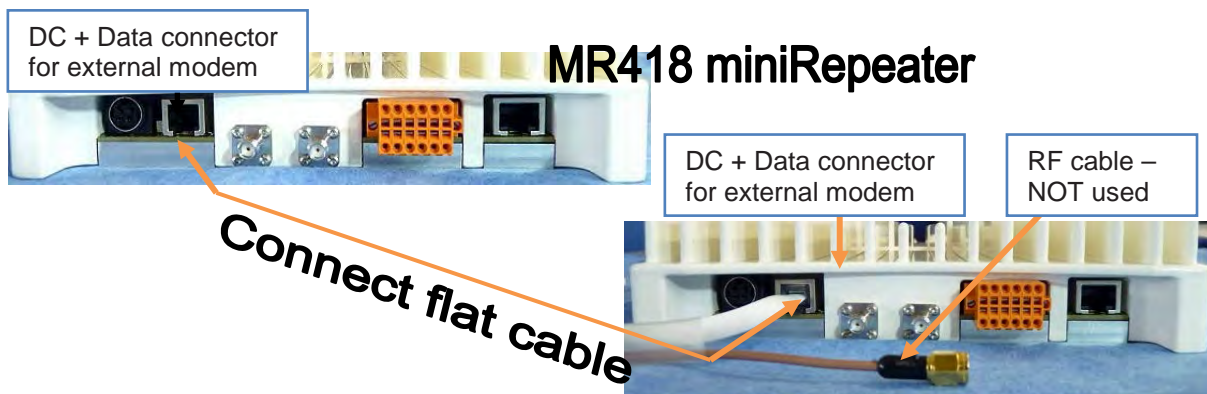

figure 4-13 Power connector of MR418

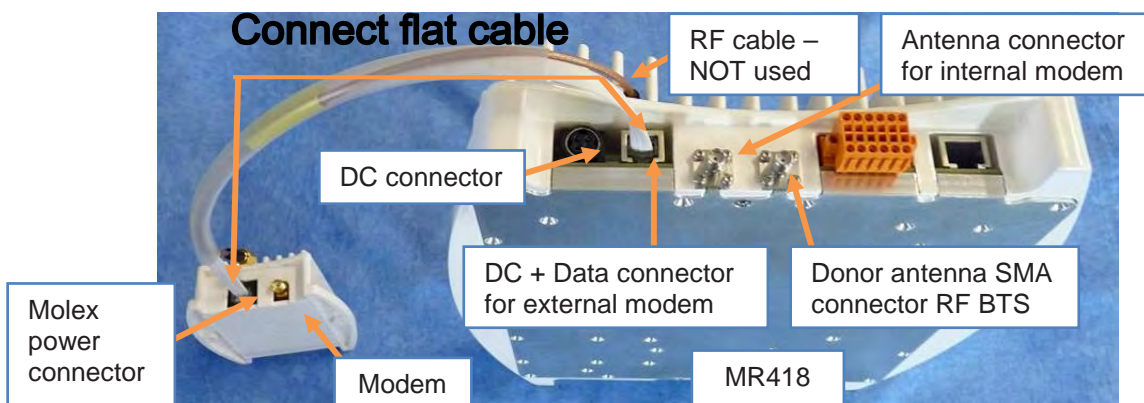

figure 4-14 Power connection of external modem with MR418

4.2.4. Power Connection of Internal Modem with the MR418

Depending on the configuration, the MR418 is optionally equipped with an internal modem that is supplied with the MR418.

The modem antenna is connected to the separate port at the MR418 repeater; there is no common antenna port for the donor antenna of the MR418 repeater and the antenna for the modem. When a common antenna for repeater and modem is required, the signals have to be combined via an external coupler.

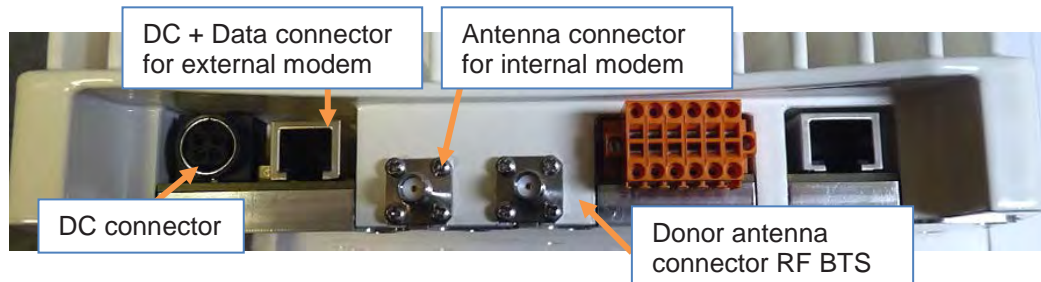

figure 4-15 Power connection of modem with MR418

5. Modem Control and Remote Access via SMS

5.1. Optional Alarming and Adjustments via SMS

Besides the transmission of alarms and heartbeat, the repeater is also configurable via SMS sent from A.I.M.O.S. or a mobile phone. The SMS interface is described in the following chapters.

The repeater polls the modem for any SMS received by the modem. The polling interval is max. 20 seconds.

5.2. SMS Interface – Commands and Notifications

There are two basic communication message types used within the MRx18 SMS interface:

- **Commands**
Commands are sent from a mobile or A.I.M.O.S. to the MRx18 in order to read or write repeater status or configuration values.
Every command request is responded by the MRx18 with one or more responses.
- **Notifications (alarms, response notifications)**
Notifications are sent by the MRx18 to a mobile or A.I.M.O.S. in order to report repeater events, i.e. successful actions, response of faulty commands, alarms and heartbeat.

General to all message types:

- For better legibility of this manual, any space within a message will be represented by the underscore character “_”.
- Separator between identification prefix of a command-string response and first parameter is the colon character followed by a space (“:_”)
- Variable message parameters are enclosed by angle brackets, e.g. “<UniqueSystemID>”
- Within the “<UniqueSystemID>” parameter no space characters are allowed.
- All messages are treated as case insensitive.

5.3. SMS Commands

Note:

- Every correct SMS SET/ GET command is acknowledged by sending back the current settings (as if responding to the corresponding get command.)
- When the SMS contains an error, a not-acknowledge SMS (“nak“ SMS) will be sent back.
- Note that a response SMS / not-acknowledge SMS will only be sent when all its parameters have been stored successfully to external non-volatile memory. Therefore, no response is received when the phone number the SMS command has been sent to is incorrect. SMS commands sent from a phone number deviating from the destination phone number entered are discarded even though the format of the SMS command is correct.
- Almost every SMS SET command has its associated SMS GET command (see details at description of SMS commands).
- All field parameters of a command are separated by ‘#’ character between two spaces. Please note that for reasons of better legibility, these spaces will be represented in this document by the underscore character ‘_’.
- Phone number validation:
The phone number of the SMS command sender normally always matches with the phone number configured. However, this does not apply to the *set/ get smsc* and *set/ get config* commands; for further information see chapter 5.3.1.1 *Config SMS*.

Not-Acknowledge Response (nak)

In case of an error in a set or get command in general, a **Not-Acknowledge** (“nak”) response will be sent to the SMS receiver or A.I.M.O.S..

Note:

- **“nak” response** via modem only when first command word is **set / get**
- **no “nak” response** via modem with faulty **“set configuration”** command

5.3.1.SET / GET Commands

5.3.1.1. Config SMS

The Config SMS provides all necessary information to the MRx18. This command establishes remote monitoring via SMS.

SET command:

set_config:_phone_ <+491701234567>_#_loc_ <UnitLocation>_#_ID_ <UniqueSystemID>

- phone: destination phone number (max. 20 numbers including "+"; no blanks) where all SMS messages, alarms, heartbeat are sent to. Either national or international format is allowed. The latter has to be preceded with a "+".
- loc: Unit location, is used just for information and is part of each SMS, no validation is done in this field (max. 20 characters, no blanks).
- ID: Unit ID is used for identification issues and is part of an alarm SMS, no validation is done in this field (max. 20 characters, no blanks).

The **set_config** command is accepted by the MRx18 from every sender (mobile or A.I.M.O.S.) independent of the destination phone number. The response is sent to the destination phone number.

By sending a config SMS the alarming is always enabled automatically. Alarming can be enabled/ disabled by a different command described later in this manual.

GET command:

get_config

-> SET / GET Response:

config:_phone_ <+491701234567>_#_loc_ <UnitLocation>_#_ID_ <UniqueSystemID>

5.3.1.2. Service Center Number

Use this SMS command to set the Service Center Address (= phone number). The number has to be entered in international format (e.g. +49...).

The number of the SMS Service Center is used for sending out SMS messages. In most cases this number has already been stored to the SIM card when receiving the card from the provider.

Otherwise, it is necessary to store the number of the SMS Service Center to the SIM-card inside the modem. With the following SMS it is possible to set the Service Center Address:

SET command:

set_smsc:_ <+491701234567>

- smsc: service center number (max. 20 numbers incl. "+"; no blanks) has to be entered in international format, starting with a "+"

GET command:

get_smsc

-> SET/GET Response:

smsc:_ <+491701234567>_#_loc_ <UnitLocation>_#_ID_ <UniqueSystemID>

5.3.1.3. Heartbeat Interval

The heartbeat-time interval of the MRx18 can be set/ queried by this command.

SET command:

set_h-beat:_*<interval>*

interval: range of 0 to 72 hours allowed (max. 2 characters)
0 means heartbeat is switched off.

GET command:

get_h-beat

-> SET/ GET Response:

a) heartbeat enabled:

h-beat:_*<interval>*h_(next_hbeat_in_less_than_<HeartBeat rounded to next whole hour>)_#_loc_<UnitLocation>_#_ID_<Unit ID>

b) heartbeat disabled:

h-beat:_0h_(disabled)_#_loc_<UnitLocation>_#_ID_<UniqueSystemID>

5.3.1.4. Alarm Severity

It is possible to change/ query the severity of each individual alarm. A set command gets effective for new alarms only; already raised alarms are not affected from this.

SET command:

set_alsev:_*<AlarmID1>=<severity>{#_<AlarmIDn>=<severity>}*

- <AlarmID>: A certain severity can be assigned to each alarm with ID<n>. For Alarm IDs see chapter 5.4.1 Alarm. For external alarms at the MR418 the Alarm ID is followed by the number of the alarm, e.g. 5041:1 for External Alarm 1
- <severity>: The severity is expressed in numbers from 1 to 5:
 - 1: critical
 - 2: major
 - 3: minor
 - 4: warning
 - 5: disabled
- More than one alarm severity can be changed within one SMS command by only repeating the part in curly brackets { }. However, the maximum length of 160 characters must not be exceeded.

-> SET Response:

alsev:_*<AlarmID1>=<severity>{#_<AlarmIDn>=<severity>}_#_loc_<UnitLocation>_#_ID_<UniqueSystemID>*

Note: The SET response contains the severities for all alarms, even if only one was given in the request.

GET command:

get_alsev

-> GET Response (always the severities for all alarms are responded):

alsev:_*<AlarmID1>=<severity>_#_<AlarmID2>=<severity>_#_..._#_<AlarmIDn>=<severity>_#_loc_<UnitLocation>_#_ID_<UniqueSystemID>*

5.3.1.5. Alarming Status

This command enables or disables alarming via SMS.

SET Command:

set_alarming:_ena|dis

- *Alarming enable* means that all active alarms are automatically sent to the destination phone number.
- By setting alarming to "*disable*", no alarms are sent by the modem/ mobile to the miniRepeater. The heartbeat is not affected by this setting.

GET Command:

get_alarming

-> SET/GET Response:

alarming:_ena|dis_#_loc_<UnitLocation>_#_ID_<UniqueSystemID>

5.3.1.6. Technical Setup (Settings - Radio Frequency)

In order to change RF parameters of the MRx18, an individual command per segment must be sent. The numbering of the segments is based on the naming of the MRx18 series.

The exemplary illustration below is to explain the segment numbering with relation to the MRx18 naming.

Single band/ segment: MR918



Dual segment: MR918/918

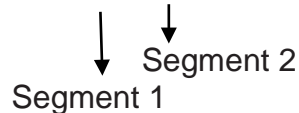

Triple segment: MR918/918/918

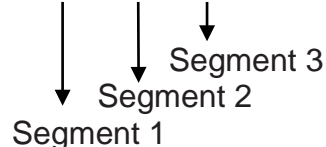

Dual band (1 segment each band): MR1818/918

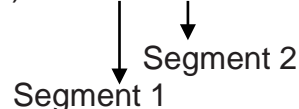

Dual band (1 segment band 1, 2 segments band 2): MR1818/918/918

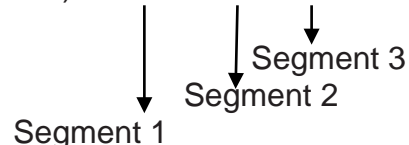

SET/ GET Segment Commands

SET command (any parameter is optional, but at least one has to be given):

set_segment <SegNo>:_freq_xxxx.xx-
yyyy.yy_#_gain__<DL>_#_Pout__<DL>_#_AG_<x>_#_AI_<y>_#_PD_<ena/dis>_#_AF_<z>

- <SegNo>: number of segment, 1 to 3
- freq: frequency setting in DL, start and stop frequency in MHz (max. 15 characters included). In case a value is entered that does not fit to the repeater type (see chapter 5.3.2.6 *Repeater Type (Model)*), a "nak" response will be received. For MR418 the frequency setting needs not be added since the bandwidth cannot be adjusted. If entries are made for the frequency setting, the values must be fit to the DL start and stop frequencies of the corresponding MR418, e.g. DL 390-395 MHz.

Note: Always enter the frequency in the format *freq_xxxx.xx-yyyy.yy*, i.e. **with frequencies <1000 MHz** always enter a "0" before the actual frequency, e.g. for 935.20 to 945.20 MHz => enter *freq_0935.20-0945.20*

- Gain: gain setting UL and DL in dB (max. 2 characters); values for the gain must not deviate from the values as stated in the specification of the corresponding repeater type (see chapter 5.3.2.6 *Repeater Type (Model)*). Otherwise, a "nak" response will be received.
- P_{out}: max output power (ALC) in UL and DL in dBm, range (max. 2 characters) depends on repeater type and on mobile network/ service, the max. rated output power must not exceed the value stated in the specification of the respective MRx18 manual. In case a value is entered that does not fit to the repeater type (see chapter 5.3.2.6 *Repeater Type (Model)*), a "nak" response will be received.
- AG: Auto Gain function (Auto Gain Time Interval), values allowed: (<x>)
0: disabled
1: 0s / 24 h
2: 0s / 12 h
3: 10s / 12 h
4: 10s / 24h
- AI: Auto Gain imbalance (*Auto Gain UL/ DL Imbalance*), UL gain is decreased by the Auto Gain imbalance value compared with DL gain, allowed values(<y>): 0; 1; 2; 3; 4; 5
- PD: power down, enable <ena> means the segment is switched off, disable <dis> means the segment is switched on

- AF: Auto Gain function (*Auto Gain Mode*): With Auto Gain activated, two different behaviors of Auto Gain can be chosen in case more than two segments per frequency band are equipped. No validation is done when only one segment per frequency band is equipped.
 - 0** $\hat{=}$ **Uniform Gain**: Gain of each segment within a frequency band assigned with "Uniform Gain" is set according to the highest DL input signal, i.e. all input levels of segments operating in "Uniform Gain" are compared, depending on the highest level, the gain is set accordingly. Gain Mode might be chosen, for instance, when frequency hopping is done between the segments.
 - 1** $\hat{=}$ **Independent Gain**: Gain of segments assigned with "Independent Gain" is set individually in order to get the maximum output power, independent of other segments operating in the same frequency range. For example, "Independent Gain" might be chosen if different services, e.g. GSM900 and UMTS900, are transmitted on a separate frequency segment allocated in one frequency band.
- All parameters are optional and need not be stated in the SMS command in case the value is not changed. Anyhow, at least one parameter has to be followed by the "set segment" command.

GET command:***get_segment* <SegNo>**

- <SegNo>: Optional number of segment, 1 to 3. If omitted, one response per segment is sent using the extended response identification (<SegNo><seq>/<Count>)

-> SET/GET Response (always all parameters are responded):

***segment* <SegNo><seq>/<Count>: _freq_xxxx.xx-
yyyy.yy_#_gain__<DL>_#_Pout__<DL>_#_AG_<x>_#_AI_<y>_#_PD_<e
na/dis_#_AF_<z>_#_loc_<UnitLocation>_#_ID_<UniqueSystemID>**

- <SegNo>: number of segment
- <seq>: number of response message
- <Count>: response messages to be received overall

Exemplary GET command of 2 segments (MR2118/918):

get_segment

Response 1:

*segment_1_1/2:_freq_2120.00_2130.00_#_gain_60_60_#_Pout_18_18_#AG_0_#_A
I_0_#_PD_dis_#_AF_1_#_loc_Buchdorf_#_ID_ExampleUniqueSystemID*

Response 2:

*segment_2_2/2:_freq_0940.00_0947.60_#_gain_60_60_#_Pout_18_18_#_AG_0_#_
AI_0_#_PD_dis_#_AF_1_#_loc_Buchdorf_#_ID_ExampleUniqueSystemID*

SET / GET Uplink Frequency Commands (not applicable for MR418)

Command **get freq ul** and command **set freq ul**

So far, the UL frequency has been inherited according to the DL frequency and the DL frequency could have been changed via the "set/get segment" command. However, from SW V3.1.0 onwards, the UL frequency can additionally be adjusted independently from the DL frequency (see "manual setting" in the GUI).

SET command

set_freq_UL: *_seg<SegNo>_#_xxxx.xx-yyyy.yy{ _#_seg<SegNo>_#_xxxx.xx-yyyy.yy}*

- <SegNo>: number of segment, 1 to 4
- xxxx.xx-yyyy.yy: frequency setting in UL, start and stop frequency in MHz
- UL frequency band of more than one segment can be changed by one SMS by just repeating the part in curly brackets { }. Maximum length of 160 characters must not be exceeded.

get_freq_UL

Set/Get Response {enclosed in curly brackets means occurrence zero, one or more times}:

freq_UL*[[<seq>[+][-]/<Count>]:_seg<SegNo>_#_xxxx.xx-yyyy.yy{ _#_seg<SegNo>_#_xxxx.xx-yyyy.yy}_#_loc_<UnitLocation>_#_ID_<UniqueSystemID>*

- <SegNo>: number of segment, 1 to 4
- xxxx.xx-yyyy.yy: frequency setting in UL, start and stop frequency in MHz

Preconditions:

Once the "set freq UL" command has been sent, the separate UL/DL entering of the frequencies is active, thus corresponding to the checkmark checked before. The separate UL/DL input can only be deactivated (i.e. unchecked checkmark before), by means of entering '0000.00-0000-00', instead of the frequency values 'xxxx.xx-yyyy.yy'. The UL frequency will be adjusted corresponding to the DL frequency:

Note: This command is only supported from SW V3.1.0 for the MRx18. This command cannot be applied for the MR418.

SET / GET RSSI Based Power Off Commands

This feature is used to switch on /disable the automatic RSSI dependent band power control. If the RSSI level exceeds the set RSSI level threshold, the band amplifiers are switched off.

Command **get_rbpo**[_<BandNo>] and command **set_rbpo**_<BandNo>

SET command

set_rbpo_<BandNo>:[_rbpoEN_<x>][_#_rbpoTHR_<Thr>][_#_rbpoOFF_<Off>][_#_rbpoLT_<LT>][_#_rbpoAT_<AT>

- <BandNo>: number of frequency band, 1 to 2

All parameters are optional, but at least one should be given:

- rbpoEN: en-/disable the RSSIBasedPowerOff functionality with 0, 1
- rbpoTHR: threshold for RSSIBasedPowerOff, -50..-20dBm (1dB steps)
- rbpoOFF: offset to threshold, where RF will switch on again, 0 to 10dB
- rbpoLT: LatencyTime, 30, 60, 180, 300, 600, 900s
- rbpoAT: Attempt to next Try to switch on again, 0, 1 to 24h in 1h steps

GET command

get_rbpo[_<BandNo>]

- <BandNo>: Optional number of segment, 1 to 2. If omitted, one response per segment is sent using the extended response identification (<SegNo>[<seq>[+]][-]]/<Count>, see also response syntax description in chapter 'General')

-> Set/Get Response (always all parameters are responded):

rbpo_<BandNo>[[<seq>[+]]-

]/<Count>]:_rbpoEN_<ena/dis>_#_rbpoTHR_<THR>_#_rbpoOFF_<Off>_#_rbpoLT_<LT>_#_rbpoAT_<AT>_#_rbpoStatus_<active/not_active>_#_loc_<UnitLocation>_#_<UnitID>

5.3.1.7. External Alarms (only MR418)

Command to change the naming of the external alarms and to edit the logic of the external alarms.

SET command:

set_extalarm:_*<AlarmID:1>*_*<TextExtAlarm1>*_*<LogicExtAlarm1>*[_#_*<AlarmID:2>*_*<TextExtAlarm2>*_*<LogicExtAlarm2>*]

An empty field parameter means no change is done.

- *<AlarmID:1/2>*: depending on external alarm number, the alarm ID for External Alarm 1 is *<5041:1>*, for External Alarm 2 is *<5041:2>*
- *<TextExtAlarm1/2>*: new designation of external alarm is entered (max. 15 characters, no blanks)
- *<LogicExtAlarm1/2>*: establishes the external alarm input logic. Note that **only “h” or “l”** characters are allowed.
For the meaning of the characters, see following explanations:
 - ”h”: **h**igh active alarm, i.e. the alarm **raises** when the alarm input is **high** and the alarm is cleared when the alarm input changes to low (after a debounce time of 10 seconds).
 - ”l”: **l**ow active alarm, i.e. the alarm **raises** when the alarm input is **low** and the alarm is cleared when the alarm input changes to high (after a debounce time of 10 seconds).
- If only the naming or logic of one external alarm are to be edited, the string of the other need not to be entered.

GET command:

get_extalarm

-> SET/ GET Response:

extalarm:_*<AlarmID:1>*_*<TextExtAlarm1>*_*<LogicExtAlarm1>*_#_*<AlarmID:2>*_*<TextExtAlarm2>*_*<LogicExtAlarm2>*

5.3.2. GET-Only Commands

5.3.2.1. Active Alarms

This command is used for requesting all currently active alarms from the miniRepeater.

Command:

get_active_alarms

Note:

Response(s) to this command always contain(s) the extended response identification (<No><seq>/<Count>; see response description in previous chapter.

a) Response when there are currently active alarms:

One response is forwarded for every active alarm according to chapter 5.4.1 Alarm, each response with extended response identification prefix.

b) Response when no alarms are active:

active_alarms|rid_<ID>_1/1:_info_#_MRx18_#_loc_<UnitLocation>_#_<leaveTimeEmpty>_#_<leaveNextHbEmpty>_#_ID_<UniqueSystemID>_#_1_#_<leaveSpEmpty>_#_no_active_alarms

rid_<ID>: optional field for system internal issues

<leaveTimeEmpty>, <leaveNextHbEmpty>, <leaveSpEmpty>: empty fields

Example:

active_alarms_1/1:_info_#_MRx18_#_loc_Buchdorf_#_#_ID_ExampleUniqueSystemID_#_1_#_#_no_active_alarms

5.3.2.2. RSSI

The command RSSI (abbr. of Received Signal Strength Indication) enables to query the DL Input Level received from the base station at the BTS antenna port of the MRx18.

Command:

get_rssi

-> Response (always all available segments are responded:

rssi:_<seg1>_dBm_#_<seg2>_dBm_#_<seg3>_dBm_#_loc_<UnitLocation>_#_ID_<UniqueSystemID>

- <segN>: RSSI value of segment N = 1..3

In case only one segment is equipped in the miniRepeater, the response command includes only segment 1:

rssi:_1_-55dBm_#_loc_Buchdorf_#_ID_ExampleUniqueSystemID

5.3.2.3. Actual Gain and Output Power

The current values of gain and output power can be received after this command has been sent.

Command:

Get_rf_status

-> Response (always all available segments are responded):

rf_status:_*<seg>_#_gain__<DL>_#_Pout__<DL>{#_<seg2>_#_gain__<DL>_#_Pout__<DL>}_#_loc_<UnitLocation>_#_ID_<UniqueSystemID>*

- *<segN>*: actual gain and output power values of segment N = 1..3

For output power levels lower than 0 dBm the message “<0” is shown. Gain and output power are stated in full 1 dB steps.

For more than one segment equipped, the part in curly brackets is repeated for each segment.

5.3.2.4. Cell Information

The GET Cell Information command (**get ci**) gets the following network information about the serving cell of the modem.

RSSI:	Received Signal Strength Indication:	-115 ... -47 dBm
CI:	Cell Identifier (hexadecimal notation):	Format: xxxx
LAC:	Location Area Code (hexadecimal notation):	Format: xxxx
PLMN:	Public Land Mobile Network:	Format: mmmnn
	mmm = MCC (mobile country code)	
	nn = MNC (mobile network code)	

Command:

get_ci

-> Response:

ci:*_rssi_<xxxx>_dBm_ci_<xxxx>_lac_<xxxx>_plmn_<mmmnn>_#_loc_<UnitLocation>_#_ID_<UniqueSystemID>*

Example:

ci_rssi_-70dBm_ci_0E40_loc_8201_plmn_26201_#_loc_Buchdorf_#_ID_Example
UniqueSystemID

5.3.2.5. Software Version

The command queries the current software version of the repeater.

get_sw-version

-> Response:

sw-

version:_MRx18_V<a.b.c.d>_#_loc_<UnitLocation>_#_ID_<UniqueSystemID>

Example:

sw-version:_MRx18_V1.0.0.1_#_loc_Buchdorf_#_ID_ExampleUniqueSystemID

5.3.2.6. Repeater Type (Model)

The command identifies the model of the repeater. The content of the response is the name of the unit determined by Andrew.

get_repeater_type

-> Response:

repeater_type:_MR<xxxx>/<yyyy>/<yyyy>_#_loc_<UnitLocation>_#_ID_<UniqueSystemID>

- <xxxx>, <yyyy>: see explanations in chapter 'Technical Setup'.

Note: /<yyyy> values are optional

5.3.2.7. Repeater Data

The ID No and serial numbers of the repeater can be captured by this command.

get_repeater_data

→ Response:

repeater_data:_MR<xxxx>[/<yyyy>/<yyyy>]_#_IDNO_<7digit ID
No>_#_SN_<8digit alphanurmerical
SN>_#_loc_<UnitLocation>_#_ID_<UniqueSystemID>

- <xxxx>, <yyyy>: see explanations in chapter 'Technical Setup'.

Note: /<yyyy> values are optional

Note: The command is only supported from SW V2.1.1 for MRx18 and from SW V1.0.0 for MR418.

5.3.3. SET-Only Command: Reboot

This command performs a reboot of the miniRepeater.

set_reboot

-> Response:

No special response is sent; system start-up notification (see chapter 5.4.3 *System Startup*) follows anyway and all active alarms are forwarded (when alarming is enabled).

5.4. Notifications

5.4.1. Alarm

Every alarm is indicated by a separate SMS message. Alarm SMSs are sent when alarming is enabled (see chapter 5.3.1.5 *Alarming Status*) and an alarm state has changed.

Format:

<severity>_#_MRx18_#_<UnitLocation>_#_<TimeStamp>_#_<NextHB>_#_<UniqueSystemID>_#_<AlarmID>:<segNo>_#_<SpecificProblem>_#_<AlarmText>

- <severity>: The following severity levels are defined for MRx18: critical, major, minor, warning, cleared
- <Timestamp>: This field is left empty as MRx18 has no Real-Time Clock (RTC).
- <NextHB>: This field contains the time in hours when the next heartbeat (HB) is expected. The value is always rounded up to next full hours, e.g. next HB in 10 hours and 1 minute => rounded up to 11.
- <AlarmID>: unique ID for each alarm
- <segNo/extAlarmNo >: segment number: 1 to 3 /
for number of external alarm:1 or 2
- <SpecificProblem>: This field is not supported => no values are provided for here.

- <AlarmText>: corresponding alarm text for <AlarmID>:<segNo>:
- <AlarmID> = 5035: "Segment <segNo> ALC UL Alarm"
- <AlarmID> = 5036: "Segment <segNo> ALC DL Alarm"
- <AlarmID> = 5037: "Segment <segNo> RSSI Alarm"
- <AlarmID> = 5038: "Segment <segNo> Current Alarm"
- <AlarmID> = 5039: "Segment <segNo> LO Alarm"
- <AlarmID> = 5040: "Segment <segNo> Temperature Alarm"
- <AlarmID> = 5041: "Ext. Alarm <extAlarmNo>
<TextExtAlarm>
- <TextExtAlarm> both external alarms can be designated by a user defined text (chapter 4.3.1.7 External Alarms). External alarms are restricted to MR418.

Example:

```
critical_#_MRx18_#_loc_Buchdorf_#_
_#_11_#_ID_ExampleUniqueSystemID_#_5035:1_#_
_Segment_1_ALC_UL_Alarm_#_
```

5.4.2. Heartbeat

The heartbeat message is forwarded after the heartbeat time interval has expired or after a power-up of the miniRepeater when heartbeat is activated.

Format:

h-beat_#_MRx18_#_<UnitLocation>_#_<TimeStamp>_#_<NextHB>_#_<Unit ID>_#_5000_#_<SpecificProblem>_#_system_is_alive(<NoOfActiveAlarms>_alarms_are_active)

- <TimeStamp>: This field is left empty as MRx18 has no Real-Time Clock (RTC).
- <NextHB>: This field contains the time in hours when the next heartbeat (HB) is expected. The value is always rounded up to next full hours, e.g. next HB in 10 hours and 1 minute => rounded up to 11.
- <SpecificProblem>: This field is not supported => no values are provided for here.
- <NoOfActiveAlarms>: i.e. number of currently active alarms

5.4.3. System Startup

This notification is sent after every startup/ restart of the MRx18, independent on the actual heartbeat configuration.

Format:

system_is_up_and_running_#_loc_<UnitLocation>_#_ID_<UniqueSystemID>

5.4.4. System Configuration Changed

When locally connected to the MRx18 this notification is sent via the web pages every time after any repeater configuration has changed. It is sent immediately after session logout of the webpage.

Format:

system_configuration_changed_#_loc_<UnitLocation>_#_ID_<UniqueSystemID>

5.5. Repeater Setup and Alarming via Ethernet (Webpages) – Modem Control

5.5.1. Setup and Alarming via Ethernet (Webpages)

Several pages are stored to the implemented web server, which are listed below:

- **Login**
 - Login window after a failed login
- **Status**
- **Settings**
 - Radio Frequency
 - Alarms
 - Modem Control
 - LAN Connectivity (change Ethernet connectivity setup)
 - User Account
- **Maintenance**
 - High-contrast
 - Help
 - Logout

Via Ethernet access the customer can change any parameters.

All functions are intended for the following browsers:

- *Internet Explorer 7* (Windows) or higher or *Mozilla Firefox* (any version)
- Netscape Version 7.0

The Modem Control page is explained in the following chapter.

However, please refer to the User's Manual of the MRx18 and/ or of the MR 418, which can be downloaded as well, for any detailed description of buttons, menu and status bars, functions and configurations provided that can be made in the webpages listed above.

5.5.2. Settings - Modem Control

	Value
Modem Type	no modem
Software Version	no valid modem found
SMSC	+491710760000
Destination Phone Number	+4915146732029
Unit Location	Buchdorf_Germany_R
Unique System ID	3a046f1b13c34ecf3617
Heartbeat Intervall	1h
Time to Next Heartbeat	0:56:42 hh:mm:ss
Alarming via SMS	enable
Test SMS Phone Number	?
Send Test SMS	<input checked="" type="checkbox"/> Send

figure 5-1 Modem Control, normal layout

Modem Control	
Parameter	Description of Value
Modem Type	Different modems can be selected for SMS remote monitoring. If a modem is connected to the repeater, it is automatically initialized during the boot process of the repeater. If no reboot is performed, the modem type has to be selected manually.
Software Version	The software version of the modem connected to the repeater is shown. If no modem is connected or the modem cannot be recognized, the message "no valid modem found" appears.
SMSC	The Service Center Phone Number (SMSC) is entered here (including country code, +CC, e.g. +49 for Germany). If the SMSC is stored to the SIM card of the modem, no entry needs to be done.
Destination Phone Number ¹⁾	Both the number of the destination for alarm messages and heartbeat SMS and the sender for SMS are determined herein. The number should be preceded with the country code (i.e. +CC, e.g. +49 for Germany). Only decimal digits are allowed, no spaces. The phone number shall consist of min. 7 decimal digits, max. 20 decimal digits.
Unit Location ¹⁾	The Unit Location is sent with each SMS to get information about e.g. address location or building where the repeater is installed. No validation is done with the entry. The Unit Location is a user-defined field. The content of Unit Location on the Modem Control page corresponds to that of the Unit Location on LAN Connectivity page. The settings are only applied in the status bar at the bottom of each page after a new login. Max. 20 characters are allowed.
Unique System ID ¹⁾	The Unique System ID is for identification of the repeater within A.I.M.O.S. software. This field is read-only.
Heartbeat Interval	A heartbeat SMS is sent after a certain period of time that can be selected in this field. The heartbeat indicates that the supervision of the repeater is working. If no heartbeat message is sent after the interval entered, the connection and supervision is down. If heartbeat interval is set to "0", the heartbeat functionality is disabled.
Time to Next Heartbeat	Depending on the heartbeat interval the time that still remains until the next heartbeat will be sent to the destination phone number is indicated.
Alarming via SMS	The alarming via SMS can be disabled in case no alarm and heartbeat SMS shall be sent to the destination phone number. However, settings can be changed or the status of the repeater can be queried via SMS, when Alarming via SMS is disabled.
Test SMS Phone Number	To check connectivity of the modem, a test SMS can be sent to a different receiver, e.g. your own mobile. The test SMS will contain Unit Location, Modem RSSI level, date, and timestamp.
Send Test SMS	Click this button to send a test SMS to the receiver entered in Test SMS Phone Number field.

¹⁾ With integration in A.I.M.O.S. a configuration SMS is sent from A.I.M.O.S. that overwrites the entries of these fields by the entries coming from A.I.M.O.S.

table 5-1 Settings - Modem Control

To make the changes valid the Apply button has to be pressed and the user has to log out.

5.5.3.Maintenance - Modem Debugging



figure 5-2 Maintenance - Modem Debugging, normal layout

In the page *Maintenance - Modem Debugging*, which is the **third** tab, current information on the modem is available (e.g. cell information). The following parameters can be queried here:

Maintenance	
Parameter	Description of Modem Debugging
Location Area Code	The Location Area Code of the existing server cell is indicated. This information is provided by the connected modem. “No network” is stated in case no modem is connected or is recognized to/by the repeater or the modem is not able to access to a mobile network.
MCC / MNC	The Mobile Country Code (MCC) and Mobile Network Code (MNC) of the server cell are indicated. The first three digits show the MCC, the last two digits the MNC. The MCC and MNC are detected by the connected modem. “No network” is stated in case no modem is connected or is recognized to/ by the repeater or the modem is not able to access to a mobile network.
Cell Information	The cell information displays the ID of the cell the modem is served. “No network” is stated in case no modem is connected or is recognized to/by the repeater or the modem is not able to access to a mobile network.
RSSI (dBm)	The received signal level at the antenna port of the modem is displayed. The loss of 25 dB of the modem coupler integrated in the repeater is considered *. “No network” is stated in case no modem is connected or is recognized to/by the repeater or the modem is not able to access to a mobile network. The recommended level of the RF input power (at modem RF port) is -50 dBm to -90 dBm.
Software Version	The software version of the modem connected to the repeater is shown. If no modem is connected or the modem cannot be recognized, the message "no valid modem found" appears.

* Note: In the MR418, no modem coupler is implemented.

table 5-2 Maintenance - Modem Debugging

6. Maintenance

Since replacing components inside the modem kits is a very time-consuming and intricate matter, we strongly recommend having it done in factory.

Read and observe chapter 1.2.

- 1. Observe the special protective measures for electrostatic-sensitive devices.**
- 2. Before disconnecting any cables, label any unlabelled cables to ensure correct re-connection. Incorrectly wired connections may destroy electronic components.**

The MRx18 modem kits do not require preventative maintenance measures.

For screwing procedures, please observe that all our screws have a right-hand thread, i.e. for fastening the screws turn the tool clockwise and for unscrewing them turn it counter-clockwise. For SMA connectors, a specified torque of 45 N/cm has to be observed. Use an appropriate tool for this.

7. Appendix

7.1. System Specifications

7.1.1. Electrical Specifications

<i>Frequency ranges</i>	<i>UL</i>	<i>DL</i>
GSM850	824 MHz - 849 MHz	869 MHz - 894 MHz
(E)GSM900	880 MHz - 915 MHz	925 MHz - 960 MHz
GSM1800	1710 MHz - 1785 MHz	1805 MHz - 1880 MHz
GSM1900	1850 MHz - 1910 MHz	1930 MHz - 1990 MHz
RF input power (at modem RF port) *		-45 dBm to -105 dBm -50 dBm to -90 dBm (recommended)
Power supply, DC-Voltage		via MRx18
Power consumption		4 W

* coupling loss of modem coupler inside MRx18 approx. -25 dB, no modem coupler is implemented in MR418

All figures are typical values.

All data is subject to change without notice.

7.1.2. Mechanical Specifications

Height, width, depth	MRx18 with modem kit	82 x 82 x 30 mm (3.2 x 3.2 x 1.2 inch)
Weight (Modem kit)		0.25 kg (0.6 lb)

All data is subject to change without notice.

7.1.3. Environmental and Safety Specifications

Operating temperature range	+5°C to +40°C
-----------------------------	---------------

All data is subject to change without notice.

7.2. Spare Parts

Description:	ID No:
Modem-Kit EGS5 MRX18	7615377
Modem-Kit EGS5-2 MRX18*	7721516

* 7721516 is the successor kit for 7615377.

The Last Replaceable Unit (LRU) is the respective entire modem kit, except for the manual listed above which can be optionally ordered.

8. Index

A		M	
Active Alarms.....	37	Maintenance.....	47
Alarming.....	27	Maintenance - Modem Debugging.....	46
Appendix.....	48	Modem Control.....	27
C		N	
CE Declaration of Conformity (DoC).....	11	Notifications	
Commissioning		Alarm.....	40
General.....	15	Heartbeat.....	41
Compliance.....	7	System Configuration Changed.....	42
Config SMS.....	29	System Startup.....	42
Connection of Power			
MR418 (External Modem).....	25	O	
MR418 (Internal Modem).....	26	Output Power.....	38
MRx18 (External Modem).....	24		
Contact Addresses, Customer Support.....	12, 13	P	
D		Power Connection	
Declaration of Conformity (DoC).....	11	MR418 - External Modem.....	25
		Property Damage Warnings.....	7
E		S	
Ethernet Access.....	43	SET Alarm Severity.....	30
External Modem of MR418		SET Alarming Status.....	31
SIM Card.....	17	SET Commands.....	29
F		SET Heartbeat Interval.....	30
Functional Description.....	14	SET Reboot.....	40
		SET Service Center Number.....	29
G		SET Technical Setup.....	32
GET Active Alarms.....	37	Settings - Modem Control.....	44
GET Actual Gain and Output Power.....	38	SIM Card (External Modem).....	17
GET Alarm Severity.....	30	SMS Commands	
GET Alarming Status.....	31	Not-Acknowledge Response (nak).....	28
GET Cell Information.....	38	Not-Acknowledge SMS.....	28
GET Commands.....	29	Response SMS.....	28
GET Config SMS.....	29	SMS Interface.....	27
GET Heartbeat Interval.....	30	Notifications.....	27
GET Repeater Type.....	39	Spare Parts.....	48
GET RSSI.....	37	Specifications	
GET Service Center Number.....	29	Electrical.....	48
GET Software Version.....	39	Environmental and Safety.....	48
GET Technical Setup.....	33	Mechanical.....	48
GET-Only Commands.....	37	System Configuration Changed.....	42
		System Specifications.....	48
H		T	
Health and Safety.....	6	Technical Setup.....	31
I		W	
Inserting SIM Card.....	17	Wall Mounting	
Installation		Modem to MR418.....	19
Electrical.....	24	Modem to MRx18 Dual-/ Triple Segment.....	19
Mechanical.....	18	Modem to MRx18 Dual-Band.....	19, 20
Internal Modem of MR418		Modem to MRx18 Single-Band.....	19
Inserting SIM Card.....	17	with Mounting Sheet.....	19
		without Mounting Sheet.....	18
L			
Local Access.....	16		

9. List of Changes

Version	Changes	Release Date
M0139AKG		21-September-2016
M0139AKH	<ul style="list-style-type: none">- ISED information added in chapters 1.1 and 1.4.- CE information updated in chapter 1.5.- Note on internal modem added in chapters 3.1 and 3.3.2.- RSSI Based Power Off commands added in chapter 5.3.1.6.	28-February-2018

COMMSCOPE®