

# COMMSCOPE®

## MR8518/8518/1918/1918

### miniRepeater



User's Manual  
**M0139AHJ**

**DISCLAIMER:**

This document has been developed by CommScope, and is intended for the use of its customers and customer support personnel. The information in this document is subject to change without notice. While every effort has been made to eliminate errors, CommScope disclaims liability for any difficulties arising from the interpretation of the information contained herein. The information contained herein does not claim to cover all details or variations in equipment, nor to provide for every possible incident to be met in connection with installation, operation, or maintenance. This document describes the performance of the product under the defined operational conditions and does not cover the performance under adverse or disturbed conditions. Should further information be desired, or should particular problems arise which are not covered sufficiently for the purchaser's purposes, contact CommScope.

CommScope reserves the right to change all hardware and software characteristics without notice.

**COPYRIGHT:**

© Copyright 2017 CommScope Inc. All Rights Reserved.

This document is protected by copyright. No part of this document may be reproduced, stored in a retrieval system, or transmitted, in any form or by any means, electronic, mechanical photocopying, recording, or otherwise without the prior written permission of CommScope.

**TRADEMARKS**

All trademarks identified by ® or ™ are registered trademarks or trademarks, respectively, of CommScope. Names of products mentioned herein are used for identification purposes only and may be trademarks and / or registered trademarks of their respective companies.

Andrew Wireless Systems GmbH, 10-April-2017

---

**TABLE OF CONTENTS**

<b>1. GENERAL</b>	<b>6</b>
1.1. ABBREVIATIONS	6
1.2. HEALTH AND SAFETY	7
1.3. PROPERTY DAMAGE WARNINGS	7
1.4. COMPLIANCE	8
1.5. ABOUT COMMSCOPE	11
1.6. INTERNATIONAL CONTACT ADDRESSES FOR CUSTOMER SUPPORT	12
<b>2. INTRODUCTION</b>	<b>14</b>
2.1. PURPOSE	14
2.2. THE MR8518/8518/1918/1918 MINIREPEATER	14
<b>3. FUNCTIONAL DESCRIPTION</b>	<b>16</b>
3.1. GENERAL	16
3.2. DESIGN AND CONNECTORS	17
<b>4. INSTALLATION AND COMMISSIONING</b>	<b>18</b>
4.1. MECHANICAL INSTALLATION	18
4.1.1. Health and Safety for Mechanical Installation	18
4.1.2. Property Damage Warnings for Mechanical Installation	18
4.2. ELECTRICAL INSTALLATION	19
<b>5. SOFTWARE SETUP</b>	<b>23</b>
5.1. LOGIN	23
5.2. MENU BAR – BUTTONS	24
5.3. STATUS BAR	24
5.4. STATUS	25
5.5. SETTINGS	27
5.5.1. Settings - Radio Frequency	28
5.5.2. Settings - Alarms	33
5.5.3. Settings - Modem Control	33
5.5.4. Settings - LAN Connectivity	35
5.5.5. Settings - User Account	37
5.6. MAINTENANCE	38

<b>5.7.</b>	<b>LOGOUT</b>	<b>39</b>
<b>5.8.</b>	<b>UPLOAD NEW SOFTWARE VERSION</b>	<b>40</b>
<b>6.</b>	<b>OPTIONAL EQUIPMENT</b>	<b>41</b>
<b>6.1.</b>	<b>EXTERNAL MODEM (KIT)</b>	<b>41</b>
<b>6.2.</b>	<b>ANTENNA</b>	<b>41</b>
<b>6.3.</b>	<b>ADAPTER CABLE</b>	<b>41</b>
<b>7.</b>	<b>ALARMING AND SUPERVISION</b>	<b>42</b>
<b>7.1.</b>	<b>ALARM LEDS</b>	<b>42</b>
<b>7.2.</b>	<b>DISPLAY AND RESET &amp; INSTALLATION ASSISTANCE BUTTON</b>	<b>43</b>
<b>8.</b>	<b>APPENDIX</b>	<b>45</b>
<b>8.1.</b>	<b>ELECTRICAL SPECIFICATIONS</b>	<b>45</b>
<b>8.2.</b>	<b>ENVIRONMENTAL AND SAFETY SPECIFICATIONS</b>	<b>46</b>
<b>8.3.</b>	<b>MECHANICAL SPECIFICATIONS</b>	<b>46</b>
<b>8.4.</b>	<b>SPARE PARTS LIST</b>	<b>48</b>
<b>9.</b>	<b>LIST OF CHANGES</b>	<b>48</b>
<b>10.</b>	<b>INDEX</b>	<b>49</b>

**FIGURES AND TABLES**

figure 3-1 MR8518/8518/1918/1918 block diagram..... 16

figure 3-2 Connectors of MR8518/8518/1918/1918..... 17

figure 4-1 Wall-mounting bracket..... 18

figure 4-2 Wall mounting procedure..... 19

figure 4-3 Power connection of DC connector with MRx18..... 20

figure 5-1 Login page..... 23

figure 5-2 Menu-bar buttons ..... 24

figure 5-3 Status bar ..... 24

figure 5-4 Status - General & Alarms..... 25

figure 5-6 Settings - Radio Frequency ..... 28

figure 5-8 Settings - Alarms ..... 33

figure 5-9 Settings - Modem Control..... 33

figure 5-10 Settings - LAN connectivity..... 35

figure 5-11 Settings - User Account..... 37

figure 5-12 Maintenance ..... 38

figure 5-13 Logout ..... 39

figure 5-14 Upload new software version ..... 40

figure 6-1 Coverage antenna for MRx18, optional equipment ..... 41

figure 7-1 Display and alarm LEDs ..... 42

figure 7-2 Display with reset button and alarm LEDs..... 43

figure 7-3 Display - RSSI ..... 44

figure 7-4 Display - Gain UL and DL..... 44

figure 7-5 Display - P<sub>out</sub> UL and DL..... 44

figure 8-1 Cabinet drawing MR8518/8518/1918/1918 ..... 47

table 5-1 Menu-bar buttons, description ..... 24

table 5-2 Status bar, description..... 24

table 5-3 Refresh and Auto Refresh buttons ..... 25

table 5-4 Status – General..... 26

table 5-5 Status - Alarms ..... 27

table 5-6 Radio Frequency – Power ..... 28

table 5-7 Radio Frequency – General..... 31

table 5-8 Radio Frequency - Auto Gain ..... 32

table 5-9 Settings - Alarms ..... 33

table 5-10 Settings - Modem Control..... 34

table 5-11 LAN Connectivity - General ..... 36

table 5-12 LAN Connectivity - DHCP Settings..... 36

table 5-13 LAN Connectivity - SNMP Settings..... 37

table 5-14 Settings - User Account..... 37

table 5-15 Maintenance - Modem Debugging..... 38

table 5-16 Maintenance - Software Update ..... 39

table 5-17 Maintenance - Webpage Update ..... 39

table 7-1 Alarm LEDs ..... 42

# 1. General

## 1.1. Abbreviations

3GPP	3 <sup>rd</sup> Generation Partnership Project	MR	Microwave Repeater
ALC	Automatic Level Control	MS	Mobile Station
AMPS	American Mobile Phone System or Advanced Mobile Phone System	MTBF	Mean Time Between Failures
BCCH	Broadcast Control Channel	OIP-3	Output Intercept Point of the 3rd Order
BITE	Built-In Test Equipment	OMC	Operation and Maintenance Center
BTS	Base Transceiver Station	PA	Power Amplifier
CDMA	Code Division Multiple Access	PCMCIA	Personal Computer Modem Communication International Association
CEPT	Conférence Européenne des Postes et Télécommunications	PCS	Personal Communication System
CF	Center Frequency	PSTN	Public Switched Telephone Network
CFO	Center Frequency Offset	PSU	Power Supply Unit
CFR	Code of Federal Regulations	R&TTE	Radio & Telecommunications Terminal Equipment
DL	Downlink	Rev	Revision
DoC	Declaration of Conformity	RF	Radio Frequency
EDGE	Enhanced Data Rates for GSM Evolution	RLP	Radio Link Protocol
ESD	Electrostatic Discharge	RSSI	Receive Signal Strength Indication
ETACS	Enhanced TACS	RTC	Real-Time Clock
ETS	European Telecommunication Standard	RX	Receiver
ETSI	European Telecommunication Standards Institute	SCL	Serial Clock
FSK	Frequency Shift Keying	SDA	Serial Data
GSM	Global System for Mobile Communication	SMSC	Short Message Service Center
GUI	Graphical User Interface	TACS	Total Access Communication System
I2C-Bus	Inter-Integrated Circuit Bus (Philips)	TCH	Traffic Channel
ID No	Identification Number	TDMA	Time Division Multiple Access
IF	Intermediate Frequency	TX	Transmitter
LED	Light Emitting Diode	UE	User Equipment
LMT	Local Maintenance Terminal	UL	Uplink
LNA	Low Noise Amplifier	UMTS	Universal Mobile Telecommunication System
MCC	Mobile Country Code	UPS	Uninterruptable Power Supply
MNC	Mobile Network Code	URL	Uniform Resource Locator
		VSWR	Voltage Standing Wave Ratio

## 1.2. Health and Safety



1. **Caution:** High frequency radiation in operation. Risk of health hazards associated with radiation from the antenna(s) connected to the unit. Implement prevention measures to avoid the possibility of very close proximity to the antenna(s) while in operation.

## 1.3. Property Damage Warnings



1. **Notice:** Although the repeater is internally protected against overvoltage, it is strongly recommended to ground (earth) the antenna cables close to the repeater's antenna connectors for protection against atmospheric discharge.
2. **Notice:** ESD precautions must be observed. Before commencing maintenance work, use the available grounding (earthing) system to connect ESD protection measures.
3. **Notice:** Only suitably qualified personnel are allowed to work on this unit and only after becoming familiar with all safety notices, installation, operation and maintenance procedures contained in this manual.
4. **Notice:** Keep operating instructions within easy reach and make them available to all users.
5. **Notice:** Read and obey all the warning labels attached to the unit. Make sure that all warning labels are kept in a legible condition. Replace any missing or damaged labels.
6. **Notice:** Only license holders for the respective frequency range are allowed to operate this unit.
7. **Notice:** Make sure the repeater settings are correct for the intended use (refer to the manufacturer product information) and regulatory requirements are met. Do not carry out any modifications or fit any spare parts, which are not sold or recommended by the manufacturer.

Unless otherwise agreed to in writing by CommScope, CommScope's general limited product warranty (<http://www.commscope.com/Resources/Warranties/>) shall be the warranty governing the MRx18 Units, including the installation, maintenance, usage and operation of the MRx18 Units.

## 1.4. Compliance

1. **Notice:** For installations, which have to comply with FCC RF exposure requirements, the antenna selection and installation must be completed in a way to ensure compliance with those FCC requirements. Depending on the RF frequency, rated output power, antenna gain, and the loss between the repeater and antenna, the minimum distance D to be maintained between the antenna location and human beings is calculated according to this formula:

$$D_{[cm]} = \sqrt{\frac{P_{[mW]}}{4 * \pi * PD_{[mW/cm^2]}}}$$

where

- P (mW) is the radiated power at the antenna, i.e. the max. rated repeater output power in addition to the antenna gain minus the loss between the repeater and the antenna.
- PD (mW/cm<sup>2</sup>) is the allowed Power Density limit acc. to 47 CFR 1.1310 (B) for general population / uncontrolled exposures which is
  - F (MHz) / 1500 for frequencies from 300MHz to 1500MHz
  - 1 for frequencies from 1500MHz to 100,000MHz

RF exposure compliance may need to be addressed at the time of licensing, as required by the responsible FCC Bureau(s), including antenna co-location requirements of 1.1307(b)(3).

2. **Notice:** For installations which have to comply with European EN50385 exposure compliance requirements, the following Power Density limits/guidelines (mW/cm<sup>2</sup>) according to ICNIRP are valid:
- 0.2 for frequencies from 10 MHz to 400 MHz
  - F (MHz) / 2000 for frequencies from 400 MHz to 2 GHz
  - 1 for frequencies from 2 GHz to 300 GHz
3. **Notice:** Installation of this equipment is in full responsibility of the installer, who has also the responsibility, that cables and couplers are calculated into the maximum gain of the antennas, so that this value, which is filed in the FCC Grant and can be requested from the FCC data base, is not exceeded. The industrial boosters are shipped only as a naked booster without any installation devices or antennas as it needs for professional installation.



- 4. Notice:** For installations which have to comply with FCC/Industry Canada requirements:

**English:**

This device complies with FCC Part 15 and Industry Canada license exempt RSS standard(s). Operation is subject to the following two conditions: (1) this device may not cause interference, and (2) this device must accept any interference, including interference that may cause undesired operation of the device.

This device complies with Health Canada's Safety Code. The installer of this device should ensure that RF radiation is not emitted in excess of the Health Canada's requirement. Information can be obtained at [http://www.hc-sc.gc.ca/ewh-semt/pubs/radiation/radio\\_guide-lignes\\_direct-eng.php](http://www.hc-sc.gc.ca/ewh-semt/pubs/radiation/radio_guide-lignes_direct-eng.php).

[//www.hc-sc.gc.ca/ewh-semt/pubs/radiation/radio\\_guide-lignes\\_direct-eng.php](http://www.hc-sc.gc.ca/ewh-semt/pubs/radiation/radio_guide-lignes_direct-eng.php).

Changes or modifications not expressly approved by the party responsible for compliance could void the user's authority to operate the equipment.

**French:**

Cet appareil est conforme à FCC Partie 15 d'Industrie Canada RSS standard exempts de licence (s). Son utilisation est soumise à Les deux conditions suivantes: (1) cet appareil ne peut pas provoquer d'interférences et (2) cet appareil doit accepter Toute interférence, y compris les interférences qui peuvent causer un mauvais fonctionnement du dispositif.

Cet appareil est conforme avec Santé Canada Code de sécurité 6. Le programme d'installation de cet appareil doit s'assurer que les rayonnements RF n'est pas émis au-delà de l'exigence de Santé Canada. Les informations peuvent être obtenues:

[http://www.hc-sc.gc.ca/ewh-semt/pubs/radiation/radio\\_guide-lignes\\_direct-fra.php](http://www.hc-sc.gc.ca/ewh-semt/pubs/radiation/radio_guide-lignes_direct-fra.php)

Les changements ou modifications non expressément approuvés par la partie responsable de la conformité pourraient annuler l'autorité de l'utilisateur à utiliser cet équipement.

- 5. Notice:** The power supply of the unit complies with Overvoltage Category II. It also complies with the surge requirement according to EN 61000-4-5 (fine protection); however, installation of an additional medium (via local supply connection) and/or coarse protection (external surge protection) is recommended depending on the individual application in order to avoid damage caused by overcurrent.

For Canada and US, components used to reduce the Overvoltage Category shall comply with the requirements of IEC 61643-series. As an alternative, components used to reduce the Overvoltage Category may comply with ANSI/IEEE C62.11, CSA Certification Notice No. 516, CSA C22.2 No. 1, or UL 1449. Suitability of the component for the application shall be determined for the intended installation.

- 6. Notice:** Corresponding local particularities and regulations must be observed. For national deviations, please refer to the respective documents that can be downloaded as well.

**7. Note:** For a Class A digital device or peripheral:

This equipment has been tested and found to comply with the limits for a Class A digital device, pursuant to part 15 of the FCC Rules. These limits are designed to provide reasonable protection against harmful interference when the equipment is operated in a commercial environment. This equipment generates, uses, and can radiate radio frequency energy and, if not installed and used in accordance with the instruction manual, may cause harmful interference to radio communications. Operation of this equipment in a residential area is likely to cause harmful interference in which case the user will be required to correct the interference at his own expense.

**8. Note:** For a Class B digital device or peripheral:

This equipment has been tested and found to comply with the limits for a Class B digital device, pursuant to part 15 of the FCC Rules. These limits are designed to provide reasonable protection against harmful interference in a residential installation. This equipment generates, uses and can radiate radio frequency energy and, if not installed and used in accordance with the instructions, may cause harmful interference to radio communications. However, there is no guarantee that interference will not occur in a particular installation. If this equipment does cause harmful interference to radio or television reception, which can be determined by turning the equipment off and on, the user is encouraged to try to correct the interference.

**9. Note:** This unit complies with European standard EN60950.

**Equipment Symbols Used / Compliance**

Please observe the meanings of the following symbols used in our equipment and the compliance warnings:

Symbol	Compliance	Meaning / Warning
---	FCC	For industrial (Part 20) signal booster: WARNING: This is NOT a CONSUMER device. It is designed for installation by FCC LICENSEES and QUALIFIED INSTALLERS. You MUST have an FCC LICENSE or express consent of an FCC Licensee to operate this device. Unauthorized use may result in significant forfeiture penalties, including penalties in excess of \$100,000 for each continuing violation.
		For (Part 90) signal booster: WARNING: This is NOT a CONSUMER device. It is designed for installation by FCC LICENSEES and QUALIFIED INSTALLERS. You MUST have an FCC LICENSE or express consent of an FCC Licensee to operate this device. You MUST register Class B signal boosters (as defined in 47 CFR 90.219) online at <a href="http://www.fcc.gov/signal-boosters/registration">www.fcc.gov/signal-boosters/registration</a> . Unauthorized use may result in significant forfeiture penalties, including penalties in excess of \$100,000 for each continuing violation.
	CE	Alert sign to R&TTE To be sold exclusively to mobile operators or authorized installers – no harmonized frequency bands, operation requires license. Intended use: EU and EFTA countries
CE 0700		Indicates conformity with the R&TTE directive 1999/5/EC certified by the notified body no. 0700.

## 1.5. About CommScope

*CommScope* is the foremost supplier of one-stop, end-to-end radio frequency (RF) solutions. Part of the *CommScope* portfolio are complete solutions for wireless infrastructure from top-of-the-tower base station antennas to cable systems and cabinets, RF site solutions, signal distribution, and network optimization. For patents see [www.cs-pat.com](http://www.cs-pat.com).

*CommScope* has global engineering and manufacturing facilities. In addition, it maintains field engineering offices throughout the world.

*Andrew Wireless Systems GmbH* based in Buchdorf/Germany, which is part of *CommScope*, is a leading manufacturer of coverage equipment for mobile radio networks, specializing in high performance, RF and optical repeaters. Our optical distributed networks and RF repeater systems provide coverage and capacity solution for wireless networks in both indoor installations and outdoor environments, e.g. tunnels, subways, in-trains, airport buildings, stadiums, skyscrapers, shopping malls, hotels and conference rooms.

*Andrew Wireless Systems GmbH* operates a quality management system in compliance with the requirements of ISO 9001 and TL 9000. All equipment is manufactured using highly reliable material. To maintain highest quality of the products, comprehensive quality monitoring is conducted at all fabrication stages. Finished products leave the factory only after a thorough final acceptance test, accompanied by a test certificate guaranteeing optimal operation.

This product meets the requirements of the R&TTE directive and the Declaration of Conformity (DoC) itself. A current version of the CE DoC can be downloaded as well. Any updated version of the DoC is available upon request from the local sales offices or directly from *CommScope* via the local Customer Support at one of the addresses listed in the following chapter.

**According to the DoC, our "CE"-marked equipment can be used in all member states of the European Union.**

**Note:** Exceptions of and national deviations from this intended use may be possible. To observe corresponding local particularities and regulations, please refer to the respective documents (also in national language) which can be downloaded as well.

To make the most of this product, we recommend you carefully read the instructions in this manual and commission the system only according to these instructions.

For technical assistance and support, please also contact the local office or *CommScope* directly at one of the addresses listed in the following chapter.

## 1.6. International Contact Addresses for Customer Support

<p style="text-align: center;"><b>Canada</b></p> <p style="text-align: center;"><b>CommScope Canada</b></p> <p>Mail 505 Consumers Road, Suite 803 Toronto M2J 4V8, Canada</p> <p>Phon +1-905-878-3457 (Office) e +1-416-721-5058 (Cell)</p> <p>Fax +1-905-878-3297</p> <p>E-mail wisupport@commscope.com</p>	<p><b>A M E R I C A S</b></p>	<p style="text-align: center;"><b>United States</b></p> <p style="text-align: center;"><b>Andrew LLC, A CommScope Company</b></p> <p>Mail 620 North Greenfield Parkway Garner, NC 27529, U.S.A.</p> <p>Phone +1-888-297-6433</p> <p>Fax +1-919-329-8950</p> <p>E-mail wisupport@commscope.com</p>	
<p style="text-align: center;"><b>Caribbean &amp; South American Region</b></p> <p style="text-align: center;"><b>CommScope Cabos do Brasil Ltda.</b></p> <p>Mail CALA Tech Support for <i>Distributed Coverage &amp; Capacity Solutions (DCCS) products:</i> Rua Guaporanga, 49 Praça Seca – Rio de Janeiro – RJ ZIP: 21320-180, Brazil</p> <p>Phone +1-815-546-7154 (Cell) +55-15-9104-7722 (Office)</p> <p>Fax + 55-15-2102-4001</p> <p>E-mail wisupport@commscope.com</p>		<p style="text-align: center;"><b>Caribbean &amp; Central American Region</b></p> <p style="text-align: center;"><b>CommScope Mexico S.A. de C.V.</b></p> <p>Mail CALA Tech Support for <i>Distributed Coverage &amp; Capacity Solutions (DCCS) products:</i> Av. Insurgentes Sur 688, Piso 6 Col. Del Valle, CP: 03100 Mexico City, Mexico</p> <p>Phone +52-55-1346-1900 (Office)</p> <p>Fax +52-55-1346-1901</p> <p>E-mail wisupport@commscope.com</p>	
<p style="text-align: center;"><b>China, India and Rest of Asia</b></p> <p style="text-align: center;"><b>Andrew International Corporation</b></p> <p>Mail Room 915, 9/F Chevalier Commercial Centre 8 Wang Hoi Rd Kowloon Bay, Hong Kong</p> <p>Phone +852-3106-6100</p> <p>Fax +852-2751-7800</p> <p>E-mail wisupport.China@commscope.com</p>		<p><b>A P A C</b></p>	<p style="text-align: center;"><b>Australia &amp; New Zealand</b></p> <p style="text-align: center;"><b>Andrew Corporation (Australia) Pty Ltd.</b></p> <p>Mail Unit 1 153 Barry Road Campbellfield VIC 3061, Australia</p> <p>Phone +613-9300-7969</p> <p>Fax +613-9357-9110</p> <p>E-mail wisupport.Australia@commscope.com</p>
<p style="text-align: center;"><b>Middle East &amp; North Africa</b></p> <p style="text-align: center;"><b>CommScope Solutions International Inc. (Branch)</b></p> <p>Mail PO Box 48 78 22 Unit 3206, Floor 32, Jumeirah Business Center 5, Jumeirah Lakes Towers, Dubai, United Arab Emirates</p> <p>Phone +971 4 390 09 80</p> <p>Fax +971 4 390 86 23</p> <p>E-mail wisupport@commscope.com</p>			<p><b>A f r i c a &amp; M i d d l e E a s t</b></p>

<b>United Kingdom</b>		<b>Scandinavia</b>	
<b>Andrew Wireless Systems UK Ltd</b>		<b>Andrew Norway (AMNW)</b>	
Mail	Unit 15, Ilex Building Mulberry Business Park Fishponds Road Wokingham Berkshire RG41 2GY, England	Mail	P.O. Box 3066 Osloveien 10 Hoenefoss 3501 Norway
Phone	+44-1189-366-792	Phone	+ 47 32-12-3530
Fax	+44-1189-366-773	Fax	+ 47 32-12-3531
E-mail	wisupport.uk@commscope.com	E-mail	wisupport@commscope.com
<b>Germany</b>		<b>France</b>	
<b>Andrew Wireless Systems GmbH</b>		<b>CommScope France</b>	
Mail	Industriering 10 86675 Buchdorf Germany	Mail	Immeuble Le Lavoisier 4, Place des Vosges 92052 Courbevoie, France
Phone	+49-9099-69-0	Phone	+33-1 82 97 04 00
Fax	+49-9099-69-930	Fax	+33-1 47 89 45 25
E-mail	wisupport@commscope.com	E-mail	wisupport@commscope.com
<b>Austria</b>		<b>Switzerland</b>	
<b>Andrew Wireless Systems (Austria) GmbH</b>		<b>CommScope Wireless Systems AG</b>	
Mail	Weglasse 10 2320 Wien-Schwechat Austria	Mail	Tiergartenweg 1 CH-4710 Balsthal Switzerland
Phone	+43-1706-39-99-10	Phone	+41-62-386-1260
Fax	+43-1706-39-99-9	Fax	+41-62-386-1261
E-mail	wisupport.austria@commscope.com	E-mail	wisupport.ch@commscope.com
<b>Italy</b>		<b>Iberia Region - Spain &amp; Portugal</b>	
<b>CommScope Italy S.r.l., Faenza, Italy</b>		<b>Andrew España S.A. A CommScope Company</b>	
Mail	Via Mengolina, 20 48018 Faenza (RA) Italy	Mail	Avda. de Europa, 4 - 2ª pta. Parque Empresarial de la Moraleja Alcobendas, Madrid 28108, Spain
Phone	+39-0546-697111	Phone	+34-91-745-20 40
Fax	+39-0546-682768	Fax	+34-91-661-87 02
E-mail	wisupport.italia@commscope.com	E-mail	wisupport.iberia@commscope.com
<b>Czech Republic</b>			
<b>CommScope Solutions Czech Republic C-Com, spol. s r.o</b>			
Mail	U Moruší 888 53006 Pardubice, Czech Republic		
Phone	+49 871 9659171 (Office) +49 171 4001166 (Mobile)		
Fax	+49 871 9659172		
E-mail	wisupport@commscope.com		

## 2. Introduction

### 2.1. Purpose

The MR8518/8518/1918/1918 miniRepeater is a bi-directional amplifier used to enhance signals between a mobile and a base station in a mobile network. It has been designed to increase signal strength in small and medium sized areas such as offices, shops, and basements. By boosting the signal level, the MR8518/8518/1918/1918 increases indoor coverage and allows high data rate connectivity.

If weak signal transmissions occur within the coverage area due to indoor applications, topological conditions or distance from the transmitter, a repeater is used to extend transmission range. In the downlink path, the repeater picks up the signals from a donor antenna of a BTS/Node B, amplifies and re-transmits it into the required dark spot. In the uplink (UL) path the repeater picks up the signals from a mobile/User Equipment (UE) and re-transmits it to the BTS/Node B.

### 2.2. The MR8518/8518/1918/1918 MINIREPEATER

The MR8518/8518/1918/1918 miniRepeater is referred to as *MRx18* in the following sections.

CommScope's MRx18 miniRepeater gives designers a simple tool to solve their small area coverage and performance issues.

The MRx18 cabinet consists of the MR8518/8518 main half and the MR1918/1918 extension half cabinet.

The MRx18 is easy to install. Also, a web-based Graphical User Interface (GUI) simplifies commissioning and configuring the equipment. The RF link (donor) towards the base station is typically fed from an outdoor antenna while the coverage area is fed by an indoor antenna.

The MRx18 supports two segments within the 850 MHz frequency band. As for the main unit MR8518/8518 the segments are equipped with a fixed bandwidth filter that are tailored for applications where Band A and Band AE or Band B and BE are to be amplified. However, the filters can be shifted within the 850 MHz frequency band by changing the start frequency. Regarding the extension cabinet of the MR1918/1918 the segments have variable bandwidths.

Auto Gain functionality enables automatic gain adjustment in order to maximize performance; however, gain may be set manually if desired.

An alarm interface with a display and LEDs indicates the status of the equipment locally. Moreover, the status and alarms of the MRx18 can be queried in the web-based GUI.



The MRx18 has an optional remote-monitoring function (see separate manual) that provides equipment alarming and basic configuration settings via a GSM-SMS. Alarm SMSs (including heartbeat) can be sent to the common Andrew OMC or to any standard SMS receiver (even a mobile phone).

Moreover, the MRx18 can be connected to LAN.

### **Features at a glance:**

- Two segments with fixed bandwidth in 850 MHz and two segments with variable bandwidth in 1900 MHz
- Variable bandwidth up to 25 MHz for 1900 MHz segments
- Easy to install due to light weight, small dimensions and Auto Gain functionality
- Integrated combiner/crossband coupler, no external devices required, common antenna ports for both segments equipped
- Easy commissioning via web-based GUI
- Automatic Level Control (ALC)
- Fixed bandwidth to match band A and AE or band B & BE
- Adjustable start frequency
- Automatic power down/up option at user-defined DL RSSI threshold
- LEDs for local alarm indication
- RSSI and status indication via display
- Optional remote control via SMS
- Connection to LAN

### 3. Functional Description

#### 3.1. General

The MR8518/8518/1918/1918 is a miniRepeater operating in the 850 MHz and 1900 MHz frequency ranges. The operation principle of the dual-segment is depicted in the following block diagram:

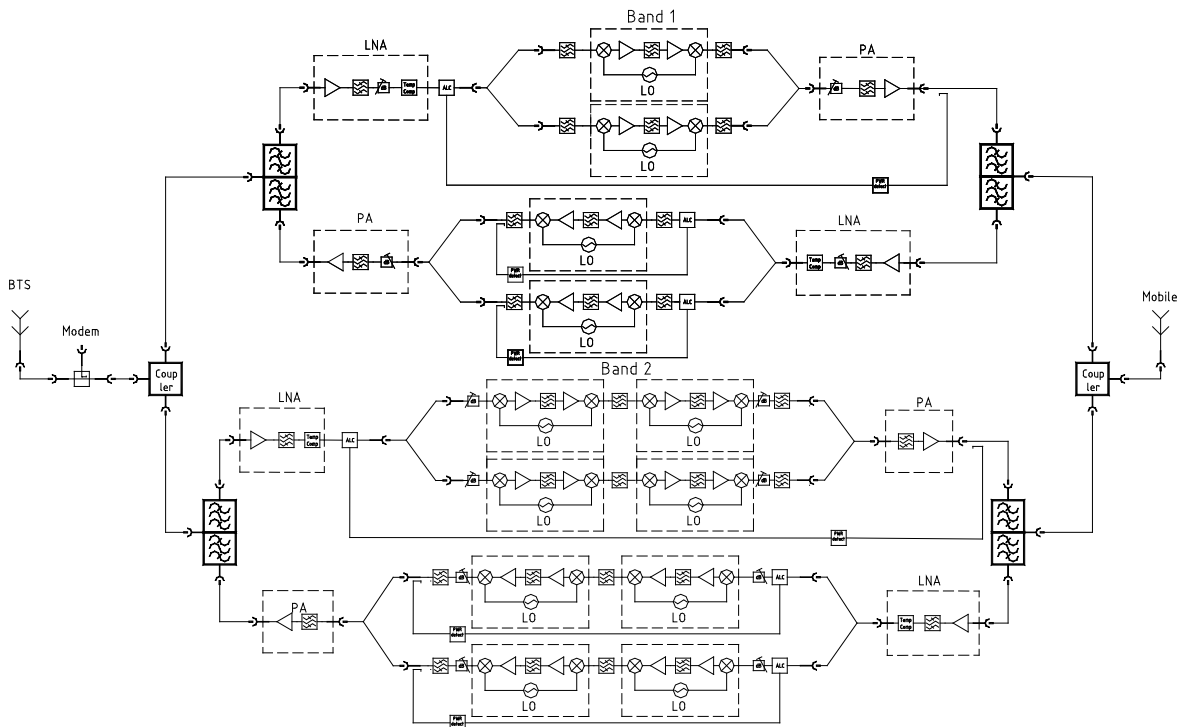

E0783BG

figure 3-1 MR8518/8518/1918/1918 block diagram



## 3.2. Design and Connectors

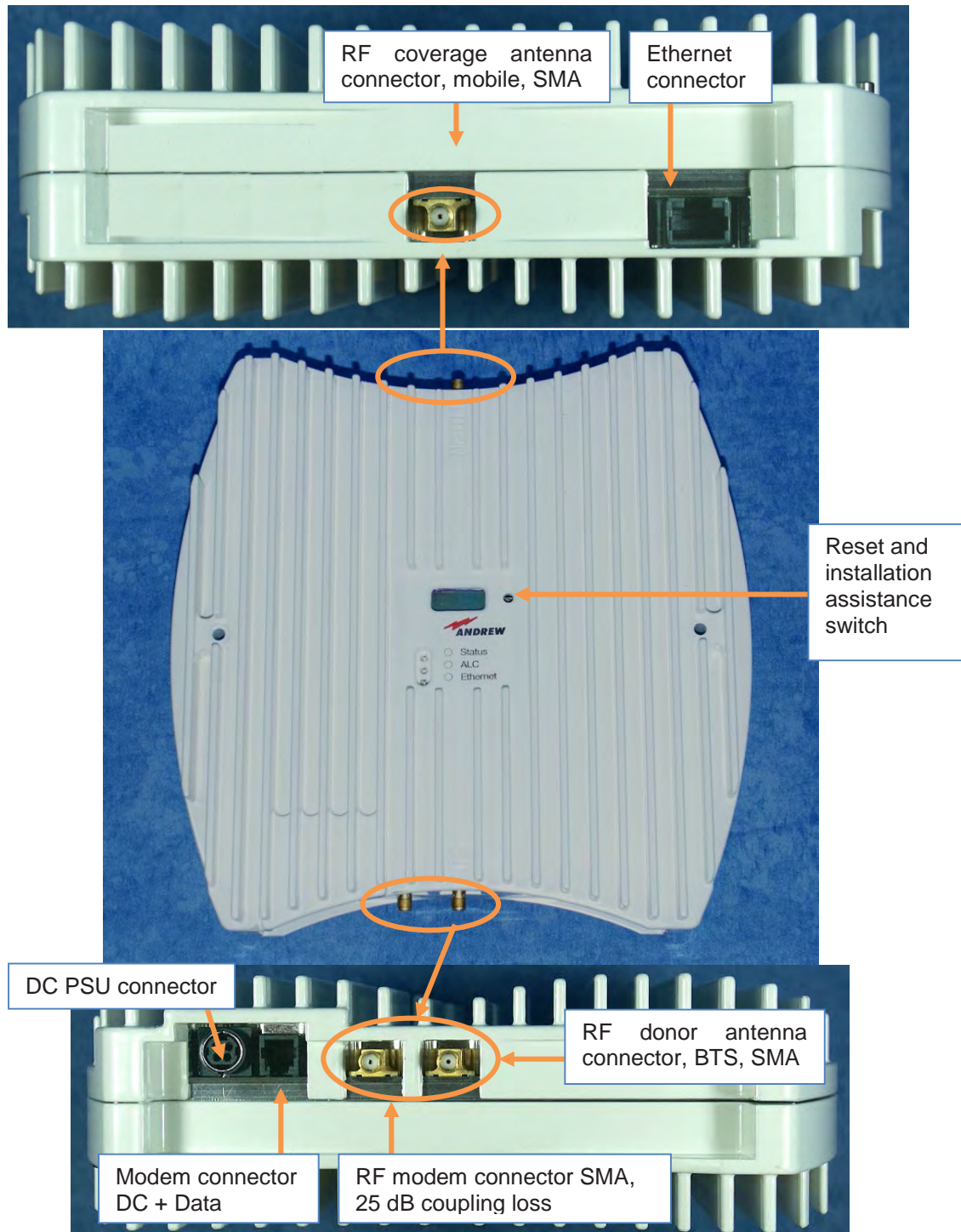

figure 3-2 Connectors of MR8518/8518/1918/1918

**Note:** SMA connectors have a specified torque of 0.45 N-m. Use an appropriate tool to fasten and unfasten these connectors. Do not over-tighten the connectors or screws.

## 4. Installation and Commissioning

### 4.1. Mechanical Installation

#### 4.1.1. Health and Safety for Mechanical Installation



1. **Caution:** Risk of serious personal injury by equipment falling due to improper installation. The installer must verify that the supporting surface will safely support the combined load of the electronic equipment and all attached hardware and components. The screws and dowels (wall anchors) used should also be appropriate for the structure of the supporting wall.

#### 4.1.2. Property Damage Warnings for Mechanical Installation

1. **Attention:** Do not install the unit in a way or at a place where the specifications outlined in the Environmental and Safety Specifications leaflet of the supplier are not met.
2. **Attention:** It is the responsibility of the installer to verify that the supporting surface will safely support the combined load of the electronic equipment and all attached hardware and components and to ensure that the unit is safely and securely mounted.
3. **Notice:** Use proper mounting hardware depending on the structure of e.g. the wall where the unit will be installed.

To mount the MRx18 to a wall, proceed as follows:

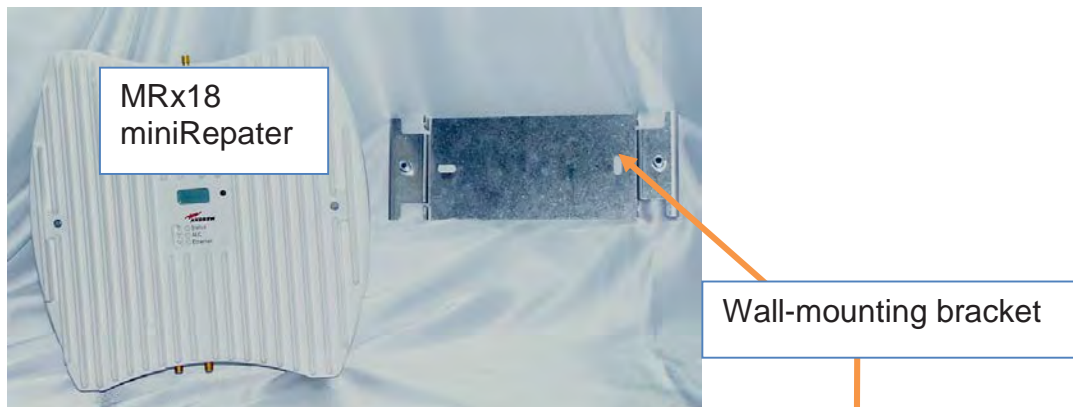

1. Use two appropriate screws and dowels to fasten the wall-mounting bracket through the two slot holes to a wall. (The screw type depends on the quality of your wall).

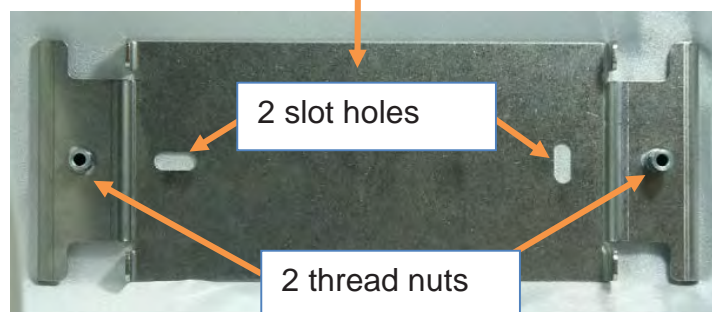
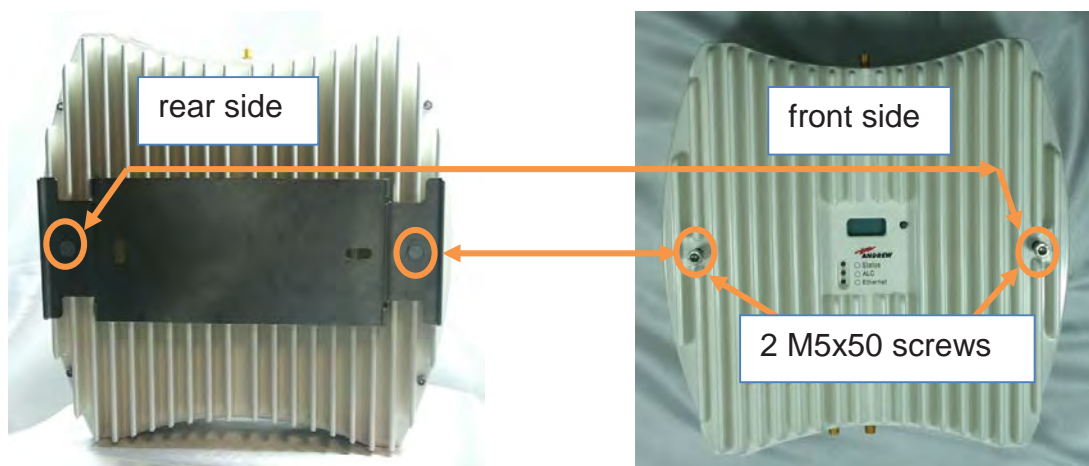

figure 4-1 Wall-mounting bracket



2. Insert the MRx18 into the wall-mounting bracket.
3. Fasten the repeater by means of 2 metric M5x50 fillister-head screws to the two thread nuts of the wall mounting bracket.

*figure 4-2 Wall mounting procedure*

## 4.2. Electrical Installation

1. **Notice:** The electrical installation has to be performed in accordance with the safety regulations of the local authorities. Due to safety reasons, the electrical installation must be performed by qualified personnel only. The repeater must not be opened.
2. **Notice:** Observe the labels on the front panels before connecting or disconnecting any cables.
  - Connect the antenna cables to the antenna connectors and the antennas.
  - Use only the power supply delivered with the unit. Do not modify the power supply unit (PSU) and cable!

### **Do not mount the PSU to the ceiling!**

- Connect the DC connector of the power supply and provide mains to the power supply. Ensure the DC connector is plugged in correctly as in the following illustrations.

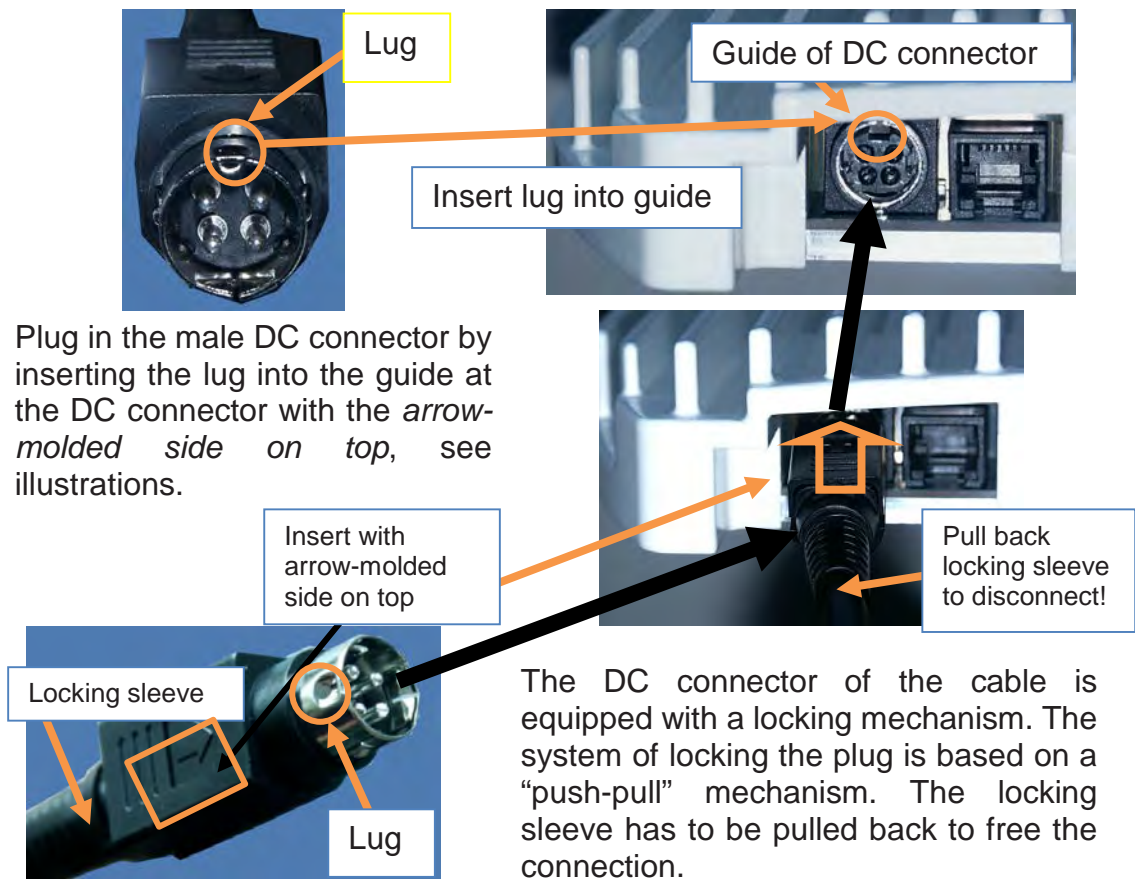

Plug in the male DC connector by inserting the lug into the guide at the DC connector with the *arrow-molded side on top*, see illustrations.

Insert with arrow-molded side on top

Pull back locking sleeve to disconnect!

The DC connector of the cable is equipped with a locking mechanism. The system of locking the plug is based on a “push-pull” mechanism. The locking sleeve has to be pulled back to free the connection.

figure 4-3 Power connection of DC connector with MRx18

- Align the donor antenna towards the BTS. The MRx18 provides antenna alignment assistance. Therefore, press the "Reset and installation assistance" switch (see chapter 3.2 *Design and Connectors*) for at least *four* seconds **after** (!) the boot process has been finished (i.e. red ALC LED is blinking for four seconds). This will set the gain to max. value and disable Auto Gain for about four minutes. The status LED will be blinking red/green. Align the donor antenna towards the BTS tower to reach the highest RSSI level possible. Check the RSSI level at the display (see figure 7-3). By pushing the reset-and-installation-assistance switch the RSSI level of each assembled segment (up to three segments) can be displayed (see chapter 7.2 *Display and Reset & Installation Assistance Button*). After four minutes Gain and Auto Gain are adjusted to the values prior to the activation of the antenna alignment.
- Align the coverage antenna.

As the default settings of the repeater are set to 'Auto Gain enabled', only the frequencies have to be adjusted. Additionally, the repeater can be customized with a laptop or PC via Ethernet connector:

- For local connection, connect the **straight** CAT 6 patch cable to the Ethernet connector of the MRx18 and the network connector of a laptop or PC. For MRx18 connection to a LAN network connect the **cross-over** cable. (Note: The MRx18 operates at 10 Mbps and full-duplex).



- Start a browser (e.g. Internet Explorer recommended versions 10 or 11, or Mozilla Firefox, recommended versions 35 up to 44) and enter URL: **http://192.168.1.1**. For IE10/IE11 it might be necessary to set the “Browser Mode” to Compatibility View as explained at the end of this chapter.

**Note:** **If the connection cannot be established**, it might be necessary to set the IP address of the computer or laptop (Start => Settings => Control Panel => Network Connections => *Your Network-Connection* => Properties => Internet Protocol (TCP/IP) => Properties => Enable ‘Use the following IP address’ and **enter an IP address**, e.g. 192.168.1.10). **Do not use IP addresses 192.168.1.2 or 192.168.1.1!**

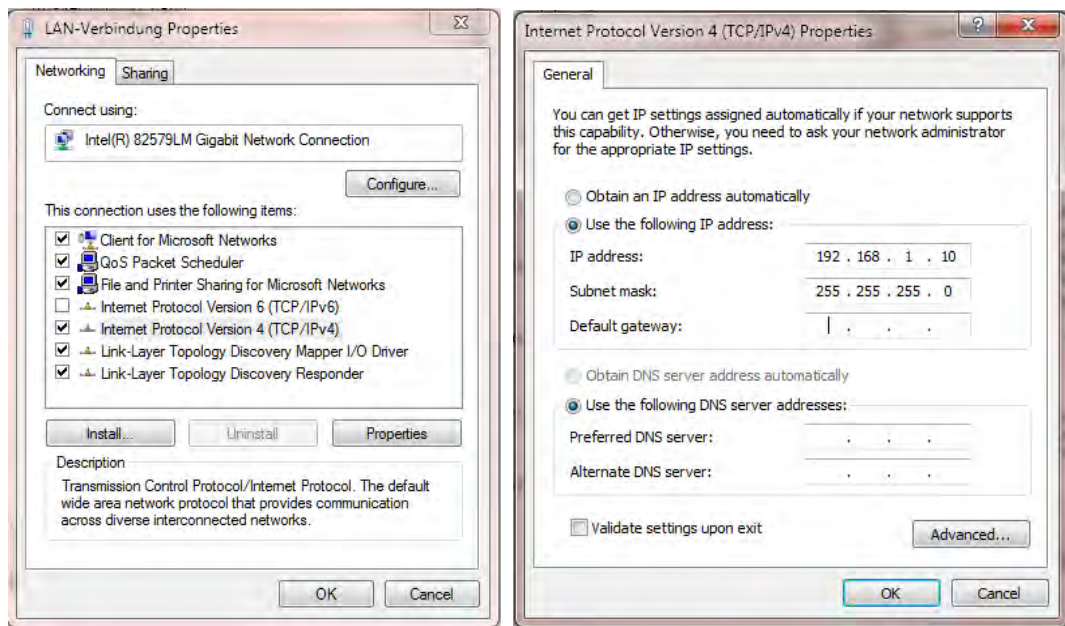

**Before changing the settings in the Internet Protocol (TCP/IP) => Properties, please write down the current settings. Ensure no proxy server for internet access is activated any longer, either.**

**After having finished setting up the MRx18, please change all the TCP/IP settings to the original ones BEFORE re-connecting your computer to any other network. Re-activate the proxy settings if necessary, too.**

- Enter User name: **MRx18** and password: **MRx18** (case-sensitive).
- Commission the repeater according to the description in the following chapter and save settings to the repeater.
- Disconnect the CAT 6 patch cable and check LEDs and display of the repeater.

In case the Ethernet connection cannot be established due to wrong settings in the Connectivity page (see chapter 5.5.4 *Settings - LAN Connectivity*) or if username or password have been forgotten, these settings can be reset to the default factory settings.

To reset Ethernet settings, username and password to the default factory settings, press the "Reset and installation assistance switch" during the boot process (i.e. red ALC LED is blinking for four seconds after power has been supplied) and keep the switch pressed until the boot process starts again (Ethernet LED starts blinking). It is not possible to execute a reset when a local connection is established.

#### Browser mode settings:

In IE10, just click „Compatibility View“:

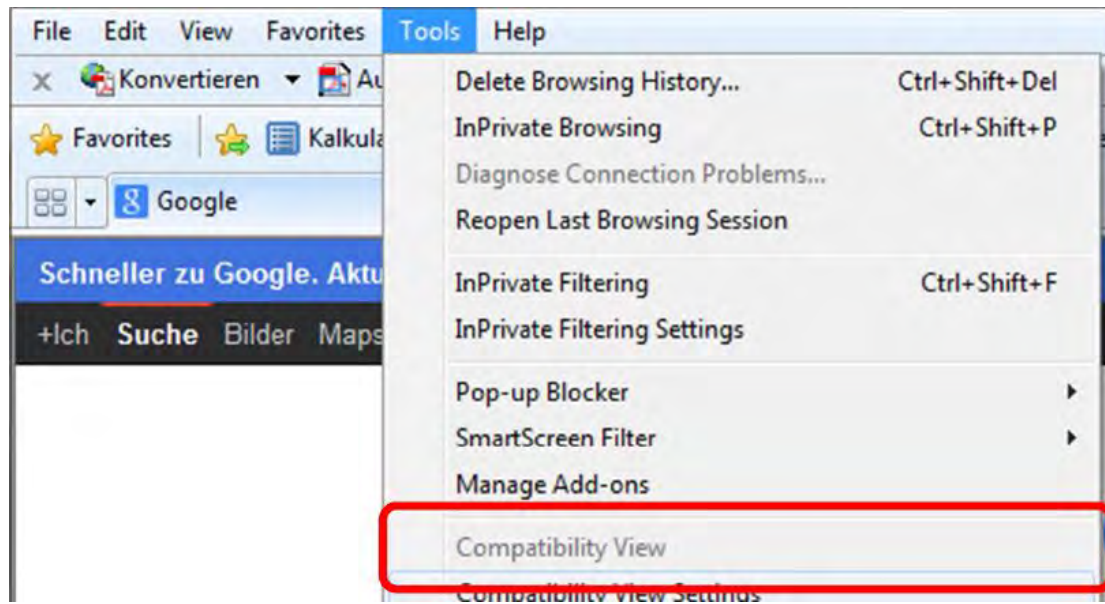

In IE11, open the „Compatibility View Settings“ and mark all checkboxes:

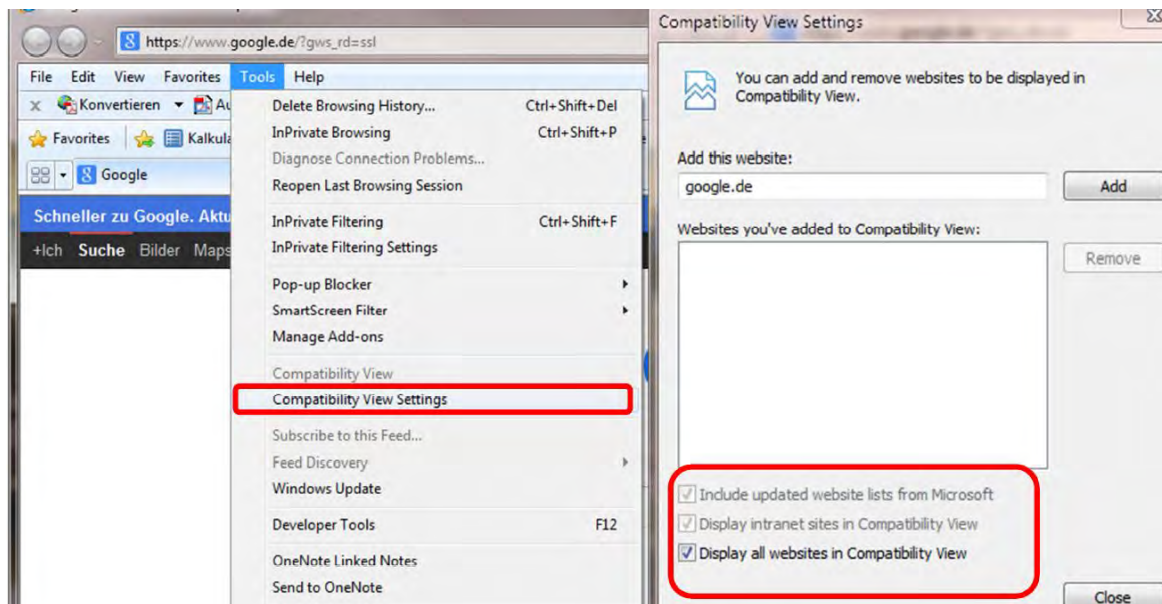

## 5. Software Setup

### 5.1. Login

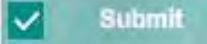

*figure 5-1 Login page*

Enter User name: MRx18

Enter Password: MRx18

Please note that passwords are case-sensitive when entering "MRx18".

Click the  button.

If an incorrect username or password has been entered, an error message appears. This message prompts to insert your username or password anew. Press key F5 to refresh the login mask.

If an incorrect username or password has been entered for three times, the interface to the repeater is locked for 30 minutes.

## 5.2. Menu Bar – Buttons

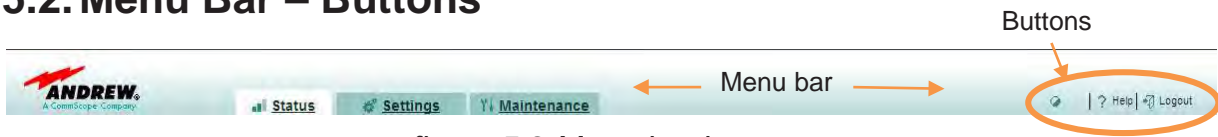

figure 5-2 Menu-bar buttons

The menu bar, which is consisting of tabs and buttons, is always visible. For description of the tabs, please refer to the following chapters. The following buttons are provided on top of the right side of the menu bar:

Button	Explanation
	The <b>first</b> button is <b>Contrast</b> . Click this button to have the webpage displayed in high contrast. To switch back into default contrast, just click on the button again and the webpage will be displayed in default contrast again. High-contrast Webpages are available for each of the Status, Settings, and Maintenance pages (an example of a high-contrast page is shown in chapter 5.4).
Help	The <b>second</b> button is <b>Help</b> . This button provides context-sensitive help to the Status, Settings and Maintenance pages. By clicking this button, a help page for detailed information will be opened immediately. Separate Help pages are available for the Status, Settings, and Maintenance pages.
Logout	The <b>third</b> button is <b>Logout</b> . Click this button to logout and quit the session. Then the logout page will be opened (see chapter 5.7 Logout).

table 5-1 Menu-bar buttons, description

## 5.3. Status Bar



figure 5-3 Status bar

The status bar is located on the bottom of each webpage. The following information is displayed: These data is being read out of the MRx18 repeater.

Designation	Description of Status Bar
<b>Unit Location</b>	Displays the unit location of the MRx18 repeater - user defined area entered in chapter 5.5.3 Settings - Modem Control or in chapter 5.5.4 Settings - LAN Connectivity.
<b>Name</b>	Displays the designation of the repeater: MRx18 - user defined, entered in chapter 5.5.4 Settings - LAN Connectivity.
<b>ID</b>	Displays the Identification Number of the MRx18 repeater.
<b>SN</b>	Displays the Serial Number of the MRx18 repeater.
<b>IP Address</b>	Displays the actual repeater IP address set: 192.168.1.1.
<b>Software</b>	Displays the current software version installed.
<b>GUI</b>	Displays the current version of the Graphical User Interface (GUI).
<b>Model</b>	Displays the specific repeater type of the MRx18.

table 5-2 Status bar, description





- General					
Band	Actual Gain (dB)		Output Power (dBm)		RSSI Level (dBm)
	DL	UL	DL	UL	
MR8518	78	78	.5	-7.5	-77
MR8518		78		-7.8	
MR1918	--	--	--	--	--
MR1918	--	--		--	

ALC		Current Consumption	Temperature	RSSI Based Power OFF
DL	UL			
not active	not active	ok	ok 50 °C	not active
	not active	ok		
--	--	--		
	--	--		active

Description of Status General Parameters	
<b>Band</b>	The equipped bands and segments are displayed.
<b>Actual Gain (dB) DL/UL</b>	The actual UL and DL gain is shown, even if Auto Gain is activated.
<b>Output Power (dBm) DL/UL</b>	The actual measured output power in DL and UL is shown, for low output power levels "<-10.0" is displayed. For DL output power, the composite output power of all segments within a frequency band is stated. For indication of output power of a single segment, the other segment must be powered down.
<b>RSSI Level (dBm)</b>	The actual DL input level at the donor antenna port is indicated. The highest input level is always displayed. If RSSI of a certain segment is required, the other segment must be powered-down.
<b>ALC DL/UL</b>	The condition of the ALC is displayed herein. When ALC is active, the ALC limit is stated in brackets, e.g. "active (18)".
<b>Current Consumption</b>	Shows if the current is within the pre-defined range.
<b>Temperature</b>	The current temperature condition is displayed. When temperature rises above 80° C, an alarm is generated and the RF section of the repeater is powered down until normal temperature is reached.
<b>RSSI Based Power OFF</b>	The condition of the automatic RSSI Based Power OFF is displayed. If the RSSI level exceeds the RSSI power off level, the band amplifier is switched off. Possible states are 'not active', 'active' and 'disabled'.

table 5-4 Status – General

Alarms						
Band	Local Oscillator	RSSI Level	ALC		Current Alarm	Temperature
			DL	UL		
MR8518	OK	OK	OK	OK	OK	OK
MR8518	OK			OK	OK	
MR1918	OK	OK	OK	OK	OK	
MR1918	OK			OK	OK	

Description of Status Alarms	
Parameter	Cause → Solution
<b>Local Oscillator</b>	The LO does not lock. → Restart repeater. If the error persists, contact technical support.
<b>RSSI Level</b>	If P-out is <-10dBm with adjusted gain on RSSI-level. → Check antenna alignment, donor antenna and antenna cables. Increase the gain.
<b>ALC DL/UL</b>	Input power too high. → Decrease gain, set "Auto Gain enabled" or decrease input power with external attenuators.
<b>Current Alarm</b>	Power consumption is not within the defined range. → Restart repeater. If the error persists, contact technical support.
<b>Temperature</b>	Temperature too high (>80°C). → Check installation location of MRx18 and improve ventilation.

table 5-5 Status - Alarms

The severity of the alarms can be changed in the Settings page (see chapter 5.5.2 *Settings - Alarms*). The latency time of each alarm is 10 seconds\*, i.e. the repeater has to be in alarm condition for 10 seconds before an alarm is notified.

\* Exception: The latency time of the Current Alarm was set to 60s with SW V3.1.4.

## 5.5. Settings

In the Settings pages current information on settings of all parameters is shown. The settings of these parameters can be changed in those pages.

The sub-tabs of the Settings page are the following:

- *Radio Frequency*
- *Alarms*
- *Modem Control*
- *LAN Connectivity*
- *User Account*

### Note:



Changed settings at the Settings pages will only become valid by clicking the Apply button. Then all changes made will be saved to the repeater.



Additionally, changes made to Settings – LAN Connectivity and Settings – User Account require a logout by the user to make the changes valid. After a disconnection without Logout or a timeout of the session, changes in these tabs will not be applied.

### 5.5.1. Settings - Radio Frequency

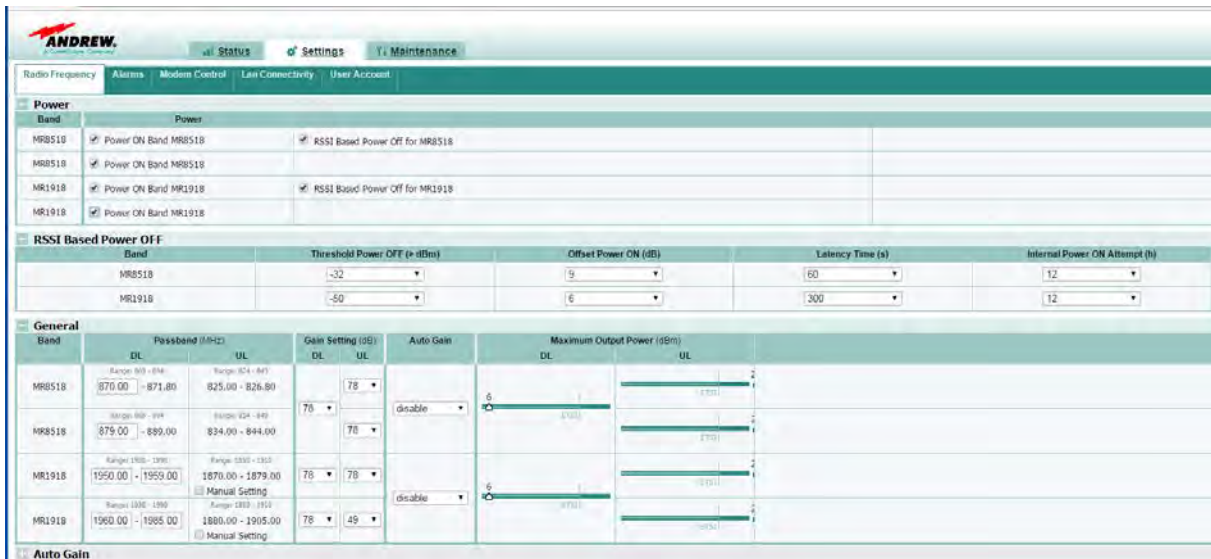

figure 5-5 Settings - Radio Frequency

Power		
Band	Power	
MR8518	<input checked="" type="checkbox"/> Power ON Band MR8518	<input checked="" type="checkbox"/> RSSI Based Power Off for MR8518
MR8518	<input checked="" type="checkbox"/> Power ON Band MR8518	
MR1918	<input checked="" type="checkbox"/> Power ON Band MR1918	<input checked="" type="checkbox"/> RSSI Based Power Off for MR1918
MR1918	<input checked="" type="checkbox"/> Power ON Band MR1918	

Settings - Radio Frequency	
Parameter	Description of Power
<b>Band</b>	For the MR8518/8518/1918/1918 two segments within one frequency band are displayed.
<b>Power</b>	To power on, check "Power ON Band MRx18". Uncheck "Power ON Band MRx18" to power down the RF-section of the respective band. If the RF section is powered down, the band is not visible in the Settings page. Alarms and status information are not captured in the Status page while the band is switched off.
<b>RSSI Based Power Off</b>	Switch on /disable the automatic RSSI dependent band power control. If the RSSI level exceeds the set RSSI level threshold, the band amplifiers are switched off.

table 5-6 Radio Frequency – Power

RSSI Based Power OFF		
Band	Threshold Power OFF (> dBm)	Offset Power ON (dB)
MR8518	-32	9
MR1918	-50	6

Latency Time (s)	Internal Power ON Attempt (h)
60	12
300	12

Settings - Radio Frequency	
Parameter	Description of RSSI Based Power OFF
<b>Band</b>	These settings apply for both segments in the band.
<b>Threshold Power OFF (&gt; dBm)</b>	If the measured RSSI level exceeds this threshold, the amplifiers for this band are switched off. Possible settings are -20 to -50 dBm in steps of 1 dBm.
<b>Offset Power On (dB)</b>	Offset in dB that has to be exceeded to switch the amplifiers on again. For the above example (threshold -32 dBm, offset 9 dB) an RSSI level of -42 dBm or less switches the amplifiers on again. Possible settings are 1 to 10 dB in steps of 1 dB.
<b>Latency Time (s)</b>	Latency time in seconds that the RSSI level above the RSSI threshold has to persist to cause an amplifier switch off. Possible values are in the range from 30 to 900 seconds.
<b>Internal Power On Attempt (h)</b>	Time interval in hours after which the RSSI is measured again for the band that has been switched off due to high RSSI level. Possible values are 0, which means disabled, and 1 to 24 hours.

General					
Band	Passband (MHz)		Gain Setting (dB)		Auto Gain
	DL	UL	DL	UL	
MR8518	Range: 869 - 894 870.00 - 871.80	Range: 824 - 849 825.00 - 826.80	78	78	disable
MR8518	Range: 869 - 894 879.00 - 889.00	Range: 824 - 849 834.00 - 844.00	78	78	
MR1918	Range: 1930 - 1990 1950.00 - 1959.00	Range: 1850 - 1910 1870.00 - 1879.00 <input type="checkbox"/> Manual Setting	78	78	disable
MR1918	Range: 1930 - 1990 1960.00 - 1985.00	Range: 1850 - 1910 1880.00 - 1905.00 <input type="checkbox"/> Manual Setting	78	49	

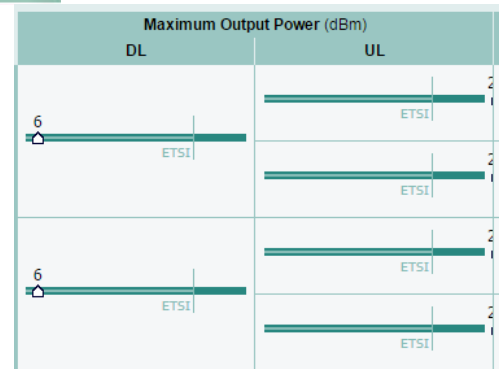

<b>Settings - Radio Frequency</b>	
<b>Parameter</b>	<b>Description of <i>General</i></b>
<b>Band</b>	For the MR8518/8518/1918/1918 two segments within one frequency band are displayed.
<b>Passband (MHz) DL/UL</b>	<p>For 850 MHz, enter the start frequency; the stop frequency results from the bandwidth of the filter equipped. For variable bandwidth in 1900 MHz, the start and stop frequencies for DL can be entered. When <b>Manual Setting</b> is not activated, the UL passband is set according the DL passband. Enter the frequency values within the duplexer range DL that is indicated above the field. Step size is 10 kHz.</p> <p><b>Note:</b> If different modulation types (e.g. LTE, UMTS, GSM, ...) have to be transmitted within one frequency band, different segments have to be used.</p> <p>In case frequencies are entered that would fall into the passband of the other segment equipped or are outside the duplexer range, a warning message will appear. For the MR8518/8518/1918/1918 consisting of two segments within one frequency band, the individual user bands must not overlap.</p> <p>For the UL, <b>Manual Setting</b> can be activated or deactivated. When Manual Setting is activated, the UL passband can be adjusted independently from the DL frequency setting.</p>
<b>Gain Setting (dB) DL/UL</b>	<p>Select or enter the gain for UL and DL in the range from 48 dB to 78 dB or enable Auto Gain.</p> <p>When Auto Gain is enabled, the entries are not applied.</p>
<b>Auto Gain</b>	<p>With Auto Gain activated, the repeater will automatically set its gain to the max. value. Depending on the DL input level, gain is decreased to optimize the output power to the value adjusted at the <i>Max. Output Power (dBm) DL</i> without reaching the ALC level. Gain is increased after the time selected at <i>Auto Gain Time Interval</i> has expired, when the DL input level decreases. UL gain is set accordingly with respect to Auto Gain imbalance setting.</p>





Auto Gain			
Band	UL/DL Imbalance (dB)	Time Interval	Mode
MR8518	0	0s / 24h	
MR8518			
MR1918	0	0s / 24h	Independent Gain
MR1918			

Settings - Radio Frequency	
Parameter	Description of Auto Gain *
<b>Band</b>	For the MR8518/8518/1918/1918 two segments within one frequency band are displayed.
<b>UL/DL Imbalance (dB)</b>	When Auto Gain is enabled, the gain is adjusted automatically. With an entry in the Auto Gain imbalance field <i>UL/DL Imbalance (dB)</i> , the UL gain is decreased compared to the DL gain for this value.
<b>Time Interval</b>	<p>Possibility to select between four behaviors of Auto Gain:</p> <p><b>0s / 24h:</b> Gain is reduced without latency time in case of too high input power. Every 24 hours the repeater tries to increase gain by 1 dB to max. output power in case input power has decreased again.</p> <p><b>0s / 12h:</b> See above, but the interval for a try to increase gain again is 12 hours.</p> <p><b>10s / 12h:</b> Gain is reduced after a latency time of 10s in case of too high input power. Interval for a try to increase gain again is 12 hours.</p> <p><b>10s / 24h:</b> See above, but the interval for a try to increase gain again is 24 hours.</p> <p><b>Note:</b> This setting (10s/24h) is recommended for <b>LTE, UMTS, and HSDPA.</b></p>
<b>Mode</b>	<p>With Auto Gain activated, two different behaviors of Auto Gain can be chosen from:</p> <p><b>Uniform Gain:</b> Gain of each segment within a frequency band assigned with "Uniform Gain" is set according to the highest DL input signal, i.e. all input levels of segments operating in "Uniform Gain" are compared, depending on the highest level, the gain is set accordingly. Gain Mode might be chosen if frequency hopping is done between the segments for instance.</p> <p><b>Independent Gain:</b> Gain of segments assigned with "Independent Gain" is set individually in order to get the max. output power, independent of other segments operating in the same frequency range. For example, "Independent Gain" might be chosen if different services, e.g. GSM900 and UMTS900, are transmitted on a separate frequency segment allocated in one frequency band.</p> <p><b>Note:</b> The selection of Uniform Gain/Independent Gain is only possible for 1900 MHz; for 850 MHz NO settings can be made. With 850 MHz Uniform Gain is only available as mode setting.</p>

\* When Auto Gain is disabled, these parameters cannot be accessed.

table 5-8 Radio Frequency - Auto Gain



### 5.5.2. Settings - Alarms



figure 5-6 Settings - Alarms

Parameter	Description of Severity
<b>ALC UL/DL</b>	A severity level can be assigned to each alarm. It is also possible to disable alarms. The severity of alarms may be:  disabled, warning, minor, major, critical
<b>RSSI Level</b>	
<b>Current Alarm</b>	
<b>Local Oscillator</b>	
<b>Temperature</b>	

table 5-9 Settings - Alarms

### 5.5.3. Settings - Modem Control

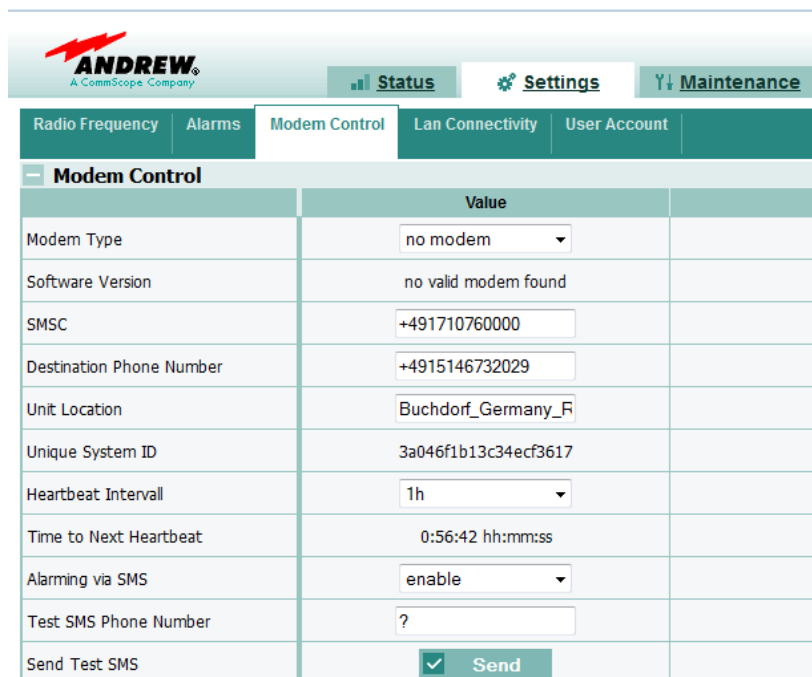

figure 5-7 Settings - Modem Control

<b>Modem Control</b>	
<b>Parameter</b>	<b>Description of Value</b>
<b>Modem Type</b>	Different modems can be selected for SMS remote monitoring. If a modem is connected to the repeater, it is automatically initialized during the boot process of the repeater. If no reboot is performed, the modem type has to be selected manually.
<b>Software Version</b>	The software version of the modem connected to the repeater is shown. If no modem is connected or the modem cannot be recognized, the message "no valid modem found" appears.
<b>SMSC</b>	The Service Center Phone Number (SMSC) is entered here (including country code, +CC, e.g. +49 for Germany). If the SMSC is stored to the SIM card of the modem, no entry needs to be done.
<b>Destination Phone Number <sup>1)</sup></b>	Both the number of the destination for alarm messages and heartbeat SMS and the sender for SMS are determined herein. The number should be preceded with the country code (i.e. +CC, e.g. +49 for Germany). Only decimal digits are allowed, no spaces. The phone number shall consist of min. 7 decimal digits, max. 20 decimal digits.
<b>Unit Location <sup>1)</sup></b>	The Unit Location is sent with each SMS to get information about e.g. address location or building where the repeater is installed. No validation is done with the entry. The Unit Location is a user-defined field. The content of Unit Location on the Modem Control page corresponds to that of the Unit Location on LAN Connectivity page. The settings are only applied in the status bar at the bottom of each page after a new login. Max. 20 characters are allowed.
<b>Unique System ID <sup>1)</sup></b>	The Unique System ID is for identification of the repeater within A.I.M.O.S. software. This field is read-only.
<b>Heartbeat Interval</b>	A heartbeat SMS is sent after a certain period of time that can be selected in this field. The heartbeat indicates that the supervision of the repeater is working. If no heartbeat message is sent after the interval entered, the connection and supervision is down. If heartbeat interval is set to "0", the heartbeat functionality is disabled.
<b>Time to Next Heartbeat</b>	Depending on the heartbeat interval the time that still remains until the next heartbeat will be sent to the destination phone number is indicated.
<b>Alarming via SMS</b>	The alarming via SMS can be disabled in case no alarm and heartbeat SMS shall be sent to the destination phone number. However, settings can be changed or the status of the repeater can be queried via SMS, when Alarming via SMS is disabled.
<b>Test SMS Phone Number</b>	To check connectivity of the modem, a test SMS can be sent to a different receiver, e.g. your own mobile. The test SMS will contain Unit Location, Modem RSSI level, date, and timestamp.
<b>Send Test SMS</b>	Click this button to send a test SMS to the receiver entered in Test SMS Phone Number field.

<sup>1)</sup> With integration in A.I.M.O.S. a configuration SMS is sent from A.I.M.O.S. that overwrites the entries of these fields by the entries coming from A.I.M.O.S.

*table 5-10 Settings - Modem Control*

To make the changes valid the Apply button has to be pressed and the user has to log out.

## 5.5.4. Settings - LAN Connectivity



General	
	Value
DHCP	disable
Net Bios Name	MRX18
Alarming via SNMP	forwarding
Repeater Name	MRx18

DHCP Settings	
	Value
IP Address	192 .168 .1 .1
Subnet Mask	255 .255 .255 .0
Standard Gateway	192 .168 .1 .1
Primary DNS Server	192 .168 .1 .1

SNMP Settings	
	Value
Destination IP Address	192 .168 .1 .10
Unit Location	Buchdorf

figure 5-8 Settings - LAN connectivity



General	
	Value
DHCP	disable
Net Bios Name	MRX18
Alarming via SNMP	forwarding
Repeater Name	MRx18

<b>LAN Connectivity - General</b>	
<b>DHCP</b>	Default setting is DHCP disabled. With DHCP (Dynamic Host Configuration Protocol) enabled the repeater receives its IP address from the server of the LAN network. <b>No entries for IP Address, Subnet Mask, Standard Gateway and Primary DNS Server (DHCP Settings) can be made when DHCP is enabled. *</b>
<b>Net BIOS Name</b>	If Net Bios Name is supported by the LAN the repeater is connected to, the repeater can be accessed by entering the Net Bios Name in the explorer instead of the IP address. Max. 15 characters are allowed for the Net Bios Name.

To make the changes valid the Apply button has to be pressed and the user has to log out.

<b>LAN Connectivity - General</b>	
<b>Alarming via SNMP</b>	<p>Three options can be selected for the <i>Alarming via SNMP</i>:</p> <p><b>Disable:</b> Alarming via SNMP is deactivated.</p> <p><b>Forwarding:</b> SNMP V1 traps of active alarms are sent to a user-defined destination IP address. The destination IP address must be entered beyond the <i>SNMP Settings</i> item.</p> <p><b>Polling:</b> The status of the alarm can be queried. A static alarm table provides the status of the alarms.</p>
<b>Repeater Name</b>	<p>For identification, the repeater name can be changed. No validation is done with the repeater name.</p> <p>Max. 15 characters are allowed. The settings are only applied in the bar at the bottom of each page after a new login.</p>

table 5-11 LAN Connectivity - General

- DHCP Settings	
	Value
IP Address	192 . 168 . 1 . 1
Subnet Mask	255 . 255 . 255 . 0
Standard Gateway	192 . 168 . 1 . 1
Primary DNS Server	192 . 168 . 1 . 1

<b>LAN Connectivity - DHCP Settings *</b>	
<b>IP Address</b>	The IP address of the repeater can be changed herein.
<b>Subnet Mask</b>	The Subnet Mask can be changed herein.
<b>Standard Gateway</b>	The Standard Gateway can be changed herein.
<b>Primary DNS Server</b>	The primary DNS server can be changed herein.

1) When *DHCP* is enabled no entries can be made.

table 5-12 LAN Connectivity - DHCP Settings

To make the changes valid the Apply button has to be pressed and the user has to log out.

SNMP Settings	
	Value
Destination IP Address	192 . 168 . 1 . 10
Unit Location	Buchdorf

<b>LAN Connectivity - SNMP Settings</b> <sup>3)</sup>	
<b>Destination IP Address</b>	When <i>forwarding</i> of alarms via SNMP at the item <i>General - Alarming via SNMP</i> has been selected, the destination IP address has to be entered where the alarms traps ought to be sent to.
<b>Unit Location</b>	The Unit Location is sent with each SNMP alarm trap to get information about e.g. address or location/building where the repeater is installed. No validation is done with the entry. Max. 20 characters are allowed. The settings are only applied in the status bar at the bottom of each page after a new login.

<sup>3)</sup> If *polling* or *disabled* is selected at item *General - Alarming via SNMP*, these parameters cannot be accessed.

table 5-13 LAN Connectivity - SNMP Settings

To make the changes valid the Apply button has to be pressed and the user has to log out.

### 5.5.5. Settings - User Account

figure 5-9 Settings - User Account

<b>User Account</b>	
Parameter	Description of Value
<b>Username</b>	To login the user name is required. The default user name can be changed. Max. 8 characters are allowed.
<b>New Password</b>	The password to login can be changed. Max. 8 characters are allowed. The new password has to be repeated.
<b>Repeat Password</b>	

table 5-14 Settings - User Account

To make the changes valid the Apply button has to be pressed and the user has to log out.



## 5.6. Maintenance



figure 5-10 Maintenance

In the Maintenance page, which is the **third** tab, current information on the modem is available (e.g. cell information). Moreover, the Webpages can be updated and a guide to update the MRx18 software is provided here.



Description of Modem Debugging Parameters	
<b>Location Area Code</b>	The Location Area Code of the existing server cell is indicated. This information is provided by the connected modem. "No network" is stated in case no modem is connected or is recognized to/by the repeater or the modem is not able to access to a mobile network.
<b>MCC/MNC</b>	The Mobile Country Code (MCC) and Mobile Network Code (MNC) of the server cell are indicated. The first three digits show the MCC, the last two digits the MNC. The MCC and MNC are detected by the connected modem. "No network" is stated in case no modem is connected or is recognized to/by the repeater or the modem is not able to access to a mobile network.
<b>Cell Information</b>	The cell information displays the ID of the cell the modem is served. "No network" is stated in case no modem is connected or is recognized to/by the repeater or the modem is not able to access to a mobile network.
<b>RSSI (dBm)</b>	The received signal level at the antenna port of the modem is displayed. The loss of 25 dB of the modem coupler integrated in the repeater is considered. "No network" is stated in case no modem is connected or is recognized to/by the repeater or the modem is not able to access to a mobile network.
<b>Software Version</b>	The software version of the modem connected to the repeater is shown. If no modem is connected or the modem cannot be recognized, the message "no valid modem found" appears.

table 5-15 Maintenance - Modem Debugging

Software Update	
Guide for Windows	
Step1	Disconnect MRx18 from mains power
Step2	Save software file <b>MRx18Vxxx.hex</b> to the hard disk of the PC, e.g. to C:\Temp
Step3	Connect CAT6 patch cable to the ethernet port of the MRx18 and network connector of the PC
Step4	Open command prompt
Step5	After cmd.exe has been opened, type <b>tftp 192.168.1.2 PUT "C:\PATH\TO\FILE\MRx18Vxxx.hex"</b> - do not press the return key
Step6	Connect MRx18 to mains power
Step7	Press the return key during the boot process (ALC LED is flashing for four seconds)
Step8	After successful software upload, the MRx18 reboots automatically

Description of Software Update Parameters	
<b>Guide for Windows</b>	The procedure how to update the repeater software update herein.

table 5-16 Maintenance - Software Update

For software update, please also refer to chapter 5.8 Upload New Software Version.

**Note:** Observe that SW and GUI (webpage file) always have to be updated to the same version.



Description of Webpage Update Parameters	
<b>Choose .bin file</b>	The Webpages can be updated by uploading the .bin file. Choose the bin file by clicking <i>Browse...</i> and then click <i>Upload</i> to upload and update the webpage.

table 5-17 Maintenance - Webpage Update

## 5.7. Logout

The Logout page can be accessed by clicking Logout, which is the **third** button on top of the menu bar.

By clicking the **Logout** button, the session will be quit and the Login page opened:



Login

Username

Password

Submit

figure 5-11 Logout

Logout is possible from the Status, Settings, and Maintenance pages at any time.

**Note:** Certain settings made (e.g. in LAN Connectivity, User Account) will only become valid after the user has executed a manual logout.

## 5.8. Upload New Software Version

The software can be updated. The new software version is delivered as MRx18Vxxx.hex file.

Observe that from Windows 7 onwards the TFTP-Client required for the upload is deactivated by default. Therefore, it has to be activated via Control Panel → All Control Panel Items → Programs and Features → Turn Windows features on or off:

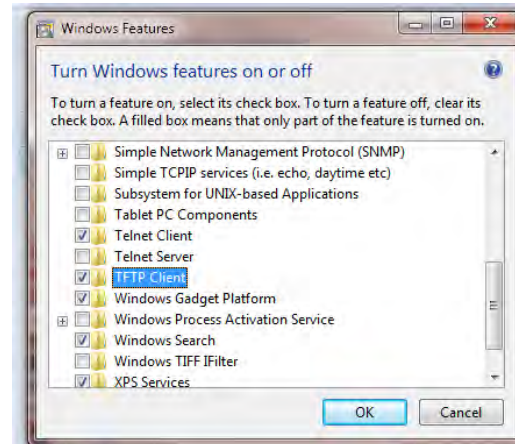

**Note:** Observe that SW and GUI (webpage file) always have to be updated to the same version.

1. Disconnect the MRx18 from mains power.
2. Save the new software version file to a folder on the hard disk or USB-stick of the laptop or PC, e.g. to C:\Temp.
3. Connect the straight CAT 6 patch cable to the Ethernet connector of the MRx18 and the network connector of this laptop or PC.
4. Open a command prompt (Start - Run...- cmd) and enter: `tftp 192.168.1.2 PUT "C:\Temp\MRx18Vxxx.hex"` (Do not press the return button, yet).

```

C:\WINDOWS\system32\cmd.exe
G:\Documents and Settings\rapanlilio>tftp

Transfers files to and from a remote computer running the TFTP service.
TFTP [-i] host [GET | PUT] source [destination]

-i           Specifies binary image transfer mode (also called
             octet). In binary image mode the file is moved
             literally, byte by byte. Use this mode when
             transferring binary files.
host        Specifies the local or remote host.
GET         Transfers the file destination on the remote host to
             the file source on the local host.
PUT         Transfers the file source on the local host to
             the file destination on the remote host.
source      Specifies the file to transfer.
destination Specifies where to transfer the file.

C:\Documents and Settings\rapanlilio>tftp 192.168.1.2 PUT "C:\Temp\MRx18U100.hex"
  
```

figure 5-12 Upload new software version

5. Provide power to the MRx18 and press the return button of the laptop or PC during the boot process (i.e. red ALC LED is blinking for four seconds). After the software upload, the MRx18 will reboot automatically.

Only the software is updated, the configuration settings made before the update are not changed.

If the software upload had not been successful, it might be necessary to set the IP address of the PC or laptop to a fixed IP address, e.g. to 192.168.1.10 (see chapter 4.2 Electrical Installation).



## 6. Optional Equipment

### 6.1. External Modem (Kit)

As an option, the MRx18 can also be equipped with an external modem for remote supervision. Besides alarm forwarding via SMS (including heartbeat), settings of the MRx18 can be changed remotely via A.I.M.O.S. or by a mobile by sending SMS commands.

Several modems are available as kits; for their exact designation please see chapter 8.4 *Spare Parts List*.

Further information is available in a separate manual, which can be downloaded as well.

**Notes:** For proper operation, the minimum level at the modem antenna port has to be  $>-100$  dBm.

The coupling loss of the modem coupler integrated in the MRx18 repeater is approx. 25 dB. Thus, the minimum level at the BTS port of the repeater has to be  $>-75$  dBm.

### 6.2. Antenna

An omni-directional multi-band coverage antenna can be directly mounted to the MRx18 antenna port (labeled *Mobile*) as illustrated to the right.



figure 6-1 Coverage antenna for MRx18, optional equipment

### 6.3. Adapter Cable

Cables with SMA male to N-female connectors can be ordered, if required. The length of the cable is 500 mm.

## 7. Alarming and Supervision

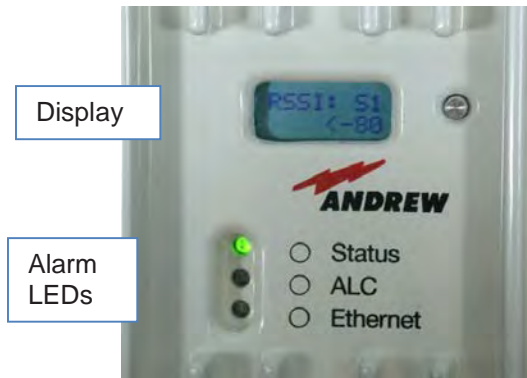

figure 7-1 Display and alarm LEDs

For alarming and supervision, the MRx18 miniRepeater is provided with an alarming interface represented by three LEDs.

Without having to connect a PC or laptop locally to the MRx18, the display provides the status information described in the following chapter.

### 7.1. Alarm LEDs

LED	Color	Function/Indication
<b>Status</b>	Off	If the LED is off, the respective MRx18 does not receive any DC power.
	Green	A green light indicates the normal operation of the repeater. Power is present and the current consumption of the unit is within the specifications.
	Orange	An orange light indicates that current consumption of the repeater is not within defined limits or the LO cannot lock and the repeater might not work properly. Faulty segment(s) is (are) identified on the display.
	Red	A red light indicates the temperature alarm, which switches to power-down mode once an over-temperature has been reached. The temperature sensor of the controller will continue to check the temperature in power-down mode. As soon as the temperature has returned to normal, the controller will enable the RF-section.
	Blinking red/green	Blinking red/green indicates the antenna alignment assistance for approx. 4 minutes.
<b>ALC</b>	Off/red	A red LED indicates that the input power received by the repeater is too high. The output power of the repeater must be limited. This will be done by the ALC. Limitation of power ensures that the final stage is not overdriven and that intermodulation is kept below the limits. The segment(s) where the ALC is activated is (are) identified in the display.
	Blinking red	The LED is blinking red for 4 seconds during the boot process.
<b>Ethernet</b>	Off/green	The LED is green if the repeater is connected via Ethernet. LED is blinking during data transfer via Ethernet connection.

table 7-1 Alarm LEDs

## 7.2. Display and Reset & Installation Assistance Button

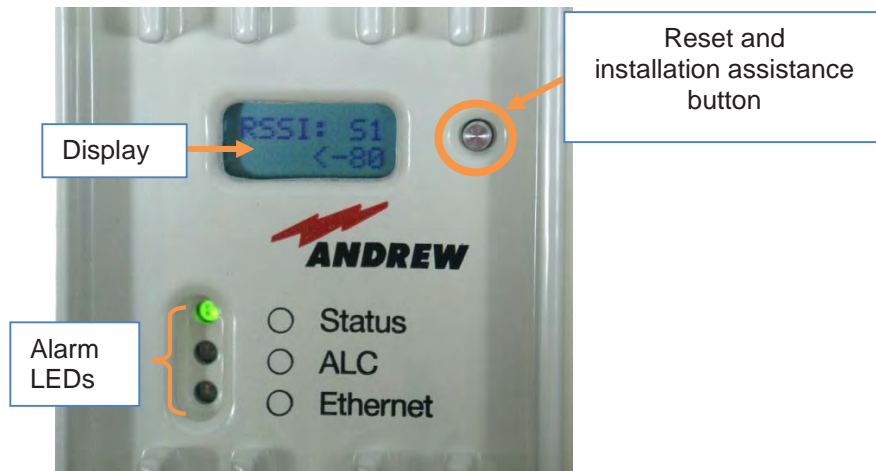

figure 7-2 Display with reset button and alarm LEDs

### Functions of the Reset Button:

- **To align the donor antenna** of the MRx18 towards the BTS via the antenna alignment assistance (as described in chapter 4.2 *Electrical Installation*), press the "Reset and installation assistance" switch (illustrated in figure above) for at least *four* seconds **after** (!) the boot process has been finished (i.e. red ALC LED is blinking for four seconds). This will set the gain to max. value and disable Auto Gain for about 4 minutes. The status LED will be blinking red/green. Align the donor antenna towards the BTS/Node B tower to reach the highest RSSI level possible. Check the RSSI level at the display (see chapter 7.2 *Display and Reset & Installation Assistance Button*). After four minutes the gain and Auto Gain are adjusted to the values prior to the activation of the antenna alignment.
- **To activate the display from sleep mode** this button has to be pressed. Even when an alarm is raised, the display will not be switched on. Thus, active alarms are initially only indicated by the LED's until the button is pressed. Then, the alarm information is indicated on the display. The display will be switched off automatically after 10 minutes even if an existing alarm is indicated on the display.
- **To reset Ethernet settings, username and password** to the default factory settings, press the 'Reset and installation assistance switch' during the boot process (i.e. red ALC LED is blinking for four seconds after power has been supplied) and keep the switch pressed until the boot process starts again (Ethernet LED starts blinking). It is not possible to execute a reset when a local connection is established.

- By pushing the reset and installation assistance button (illustrated in figure above), several pieces of **status information of the MRx18 can be queried**. Information given is on RSSI, actual gain UL and DL, actual output power UL and DL (abbreviated by Pout in the display). In case of more than one segment equipped, i.e. for dual-band and triple-segment versions, the reset and installation button is used to switch between the status information with the sequence as follows:
  - RSSI of 1<sup>st</sup> segment (S1) → Gain of 1<sup>st</sup> segment (S1) → Output power 1<sup>st</sup> segment (S1) → RSSI of 2<sup>nd</sup> segment (S2) → Gain of 2<sup>nd</sup> segment (S2) → Output power of 2<sup>nd</sup> segment (S2) → RSSI of 3<sup>rd</sup> segment (S3) → Gain of 3<sup>rd</sup> segment (S3) → Output power 3<sup>rd</sup> segment (S3) → RSSI of 4<sup>th</sup> segment (S4) → Gain of 4<sup>th</sup> segment (S4) → Output power of 4<sup>th</sup> segment (S4)

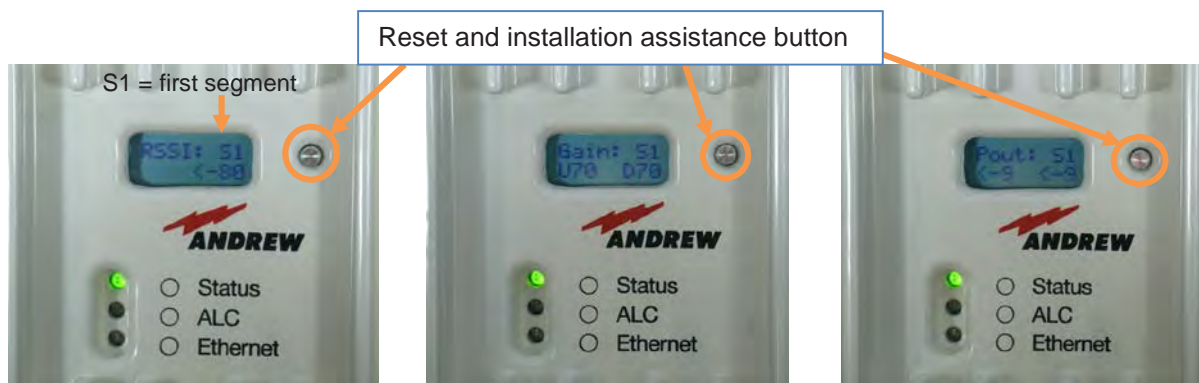

figure 7-3 Display - RSSI

figure 7-4 Display - Gain  
UL and DL

figure 7-5 Display - P<sub>out</sub> UL  
and DL

In alarm condition the display shows\* the segment and kind of alarm; when more than one alarm in different segments is raised the display changes alternately between the active alarms. When the MRx18 is in normal operation with no active alarms, "System Ok" is indicated.

\* When the display is in sleep mode it has to be activated by the "Reset and installation assistance button", first.

**Note:** When one segment is switched to "power down" the respective segment is shown in the display. When several segments are switched to power down the display changes alternately between the segments powered down.

## 8. Appendix

### 8.1. Electrical Specifications

The electrical specifications of the MR8518/8518/1918/1918 miniRepeater are basically identical to the ones of the MR8518/8518 (2 fix) main unit, which can be downloaded as well. Deviations are stated in the following table. Existing combination of the MR8518/8518/1918/1918 carries two fix-bandwidth segments in the basic cabinet MR8518/8518 and up to two variable-bandwidth segments in the extension cabinet MR1918/1918.

<b>MR8518/8518 Main Unit</b>		
Frequency range	UL DL	824 MHz to 849 MHz 869 MHz to 894 MHz
Bandwidth		fixed bandwidth, Segment 1: 1.8 MHz; Segment 2: 10 MHz start frequency adjustable (option)
Gain		78 dB
Gain adjustment range		30 dB in steps of 1
Flatness		±3 dB
RF output power <sup>1)</sup>	UL/DL	+22 dBm @ 1 carrier +19 dBm @ 2 carriers
OICP3	UL/DL	+41 dBm
Spurious emission		<-13 dBm
P-1 dBc	UL/DL	+28 dBm
Noise figure	UL/DL	9.0 dB
Delay		5 µs
Input and output impedance		50 Ohms

<b>MR1918/1918 Extension Unit</b>			
<b>1900 MHz PCS</b>			
Frequency range	UL DL	1850 MHz to 1910 MHz 1930 MHz to 1990 MHz	
Bandwidth options		variable 1 MHz to 25 MHz in steps of 10 kHz	
Gain		78 dB	
Gain adjustment range		30 dB in steps of 1 dB	
Flatness <sup>2)</sup>		±3 dB	
		<i>GSM</i>	<i>CDMA</i>
RF output power <sup>1) 2)</sup>	UL/ DL	+22 dBm @ 1 carrier +19 dBm @ 2 carriers	+22 dBm @ 1 carrier +19 dBm @ 2 carriers
OICP3 UL/DL		+41 dBm	
Spurious emission		<-13 dBm	
P-1dBc UL/DL		+28 dBm	
Noise figure UL/DL		9.0 dB @ max. gain	
Delay		5 µs	

Power supply	Mains Power	100 to 240 Vac
	Local Power	6 Vdc
Power consumption		50 Watts
Antenna port	Connectors	SMA Female
	Return loss	10 dB
Indoor antenna (optional)	Antenna gain	2.0 dBi
	Radiation	Omni

<b>System Supervision and Control</b>	
Alarms	Temperature, Current, ALC, Heartbeat
Options	SMS-Alarming

<sup>1)</sup> **Note:** The manufacturer's rated output power of this equipment is for single carrier operation. For situations when multiple carrier signals are present, the rating would have to be reduced by 3.5 dB, especially where the output signal is re-radiated and can cause interference to adjacent band users. This power reduction is to be made by means of input power or gain reduction and not by an attenuator at the output of the device.

<sup>2)</sup> degradation at 1905 - 1910 MHz in UL and 1930 - 1935 MHz in DL

All figures are typical values.

**All data is subject to change without notice.**

## 8.2. Environmental and Safety Specifications

**Note:** The specifications for environmental and safety conditions are according to ETS 300 019 (European Telecommunication Standard). For further details, please refer to the “Environmental and Safety Specifications” leaflet of the supplier.

Operating temperature range	+5°C to +40°C
Ingress protection	IP30

**All data is subject to change without notice.**

## 8.3. Mechanical Specifications

Height, width, depth	240 x 240 x 70 mm (9.5 x 9.5 x 2.8 in)
Weight	3.0 kg (6.6 lb)

**All data is subject to change without notice.**



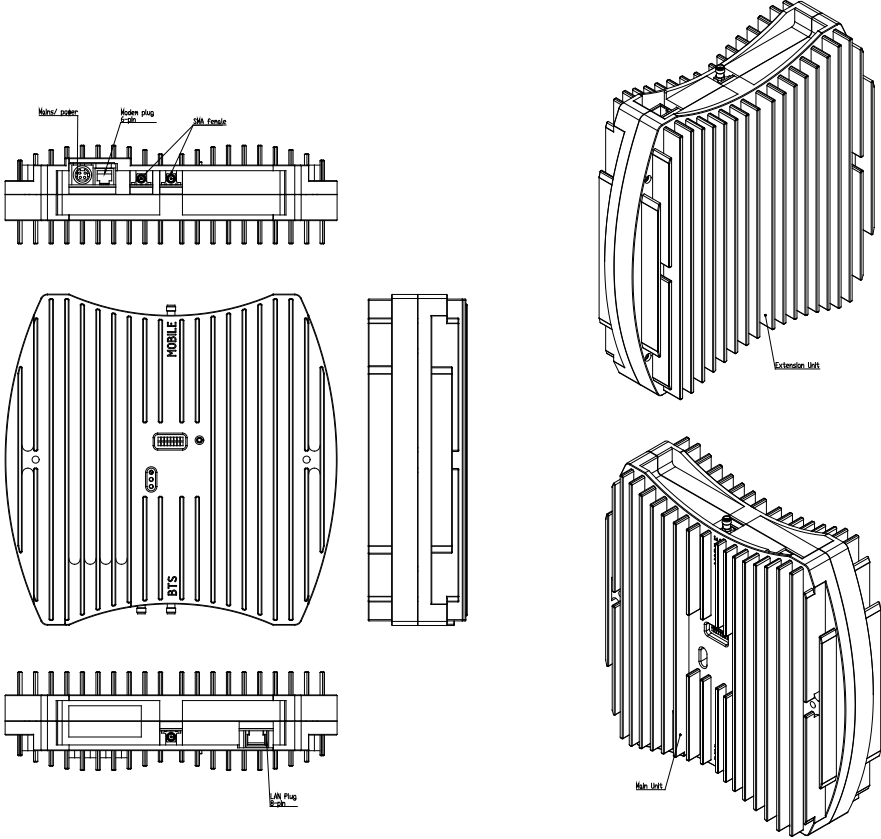

G3120Z411

figure 8-1 Cabinet drawing MR8518/8518/1918/1918

## 8.4. Spare Parts List

**Note:** When sending back the unit, use an appropriate packaging. We strongly recommend using the original packaging.

<b>Repeater: MR8518/8518/1918/1918</b>	<b>ID No: 7613704</b>
Antenna 824-960 1710-2500	7579858
RF Cable-Kit SMA to N 500 mm	7594320
Modem-Kit AEGS5-2 MRx18	7721516
Modem-Kit PHS8 MRx18	7679560
Modem-Kit EGS5 MRx18*	7615377
Mounting bracket	7610191-00
PSU Kit AC IN 100-240 V / OUT 6 V 60W AUS	7565922
PSU Kit AC IN 100-240V / OUT 6 V 60W EURO	7604783
PSU Kit AC IN 100-240V /OUT 6 V 60W IND	7565820
PSU Kit AC IN 100-240V / OUT 6 V 60W UK	7565923
PSU Kit AC IN 100-240V / OUT 6 V 60W USA	7565924
PSU Kit AC IN 100-240V / OUT 6 V 6 60W ZA	7565921

\* The Modem-Kit EGS5 is discontinued and will be replaced by Modem-Kit AEGS5-2 MRx18.

Last Replaceable Unit (LRU) is the entire miniRepeater MR8518/8518/1918/1918 listed above, except for the manual, the power supply kits and the optional equipment (antennas, RF cable kit and modem kits) listed above.

**Note:** To ensure compatibility with your system, do not order any individual components (e.g. modems) of the kits available! Make sure to always order the complete kit (ID must be listed above) as spare part.

The manufacturer reserves the right to replace the spare parts listed above by equivalent substitutes!

## 9. List of Changes

Version	Changes	Release Date
M0139AHH		13-April-2014
M0139AHJ	- chapters 5.4 and 5.5.1 updated, Automatic power down/on depending on RSSI - chapter 5.5.1 updated, 10s/24h recommended for LTE	10-April-2017

## 10. Index

<b>A</b>	
Abbreviations.....	6
Adapter Cable.....	41
Alarm LEDs .....	42
Alarming Interface	
Status .....	27
Alarming Interface, Functional Description .....	42
Alarms .....	27
Alarms (Setting).....	33
Antenna .....	41
Apply .....	27
Auto Gain .....	30, 32
Auto Refresh.....	25
<b>C</b>	
CE Declaration of Conformity (DoC).....	11
CommScope.....	11
Compliance.....	8
Connector (DC) .....	19, 20
Connectors .....	17
Contact Addresses, Customer Support .....	12
Contrast (High) Page.....	24
Contrast Button.....	24
Coverage Antenna.....	41
<b>D</b>	
DC Connector.....	19, 20
Declaration of Conformity (DoC).....	11
Design .....	17
DHCP Settings .....	36
Display.....	43
<b>F</b>	
Functional Description.....	16
<b>H</b>	
Health and Safety.....	6, 7
Help .....	24, 38
<b>I</b>	
Installation	
Antenna Alignment Assistance .....	20
Electrical .....	19
IP Address.....	20
<b>L</b>	
LAN Connectivity.....	35, 36, 37
LEDs.....	42
Login.....	39
Logout .....	24, 39
<b>M</b>	
Maintenance.....	38
Menu Bar.....	24
Modem (External).....	41
Modem Control.....	33
MR1918/1918.....	45
<b>O</b>	
Optional Equipment.....	41
<b>P</b>	
Password.....	37
Property Damage Warnings .....	7
<b>R</b>	
Radio Frequency	
Auto Gain.....	32
General.....	30
Refresh.....	25
Reset Button.....	20, 21, 43
Reset to Default.....	21
<b>S</b>	
Set	
Auto Gain.....	30
Gain .....	30
Output Power.....	31
Power-Down .....	31
RSSI threshold.....	29
Settings .....	27
Alarms .....	33
LAN Connectivity .....	35
Radio Frequency .....	28, 29, 31
Severity .....	33
SMS Alarm Forwarding .....	41
SNMP Settings .....	37
Software Upload.....	40
Software Version .....	40
Spare Parts List.....	48
Specifications	
Electrical .....	45
Environmental and Safety.....	46
Mechanical .....	46
Status .....	25
Status Bar.....	24
Supervision.....	42
System Overview.....	14
<b>T</b>	
Troubleshooting.....	27
<b>U</b>	
Uniform Gain .....	32
Upload Software.....	40

COMMScope®