

ITEM	PART NO.	DESCRIPTION	QTY.	WEIGHT
1	MDSQ301	3' Square Ice Shield	1	40.55 LBS
2	SM-U2080	UNIVERSAL SADDLE MOUNT	1	47.47 LBS
3	GB-05145	5/8" X 1-1/2" GALV BOLT KIT	4	0.04 LBS
4	GB-03145	3/8" X 1-1/2" GALV BOLT KIT	4	0.07 LBS
5	MDSQ217	Top Ice Shield Angle	1	6.38 LBS
6	MDSQ314	3' Ice Shield Support Brace	2	4.40 LBS

REVISIONS				
REV.	ZONE	DESCRIPTION	BY	DATE
A		INITIAL RELEASE	ACG	03/27/10

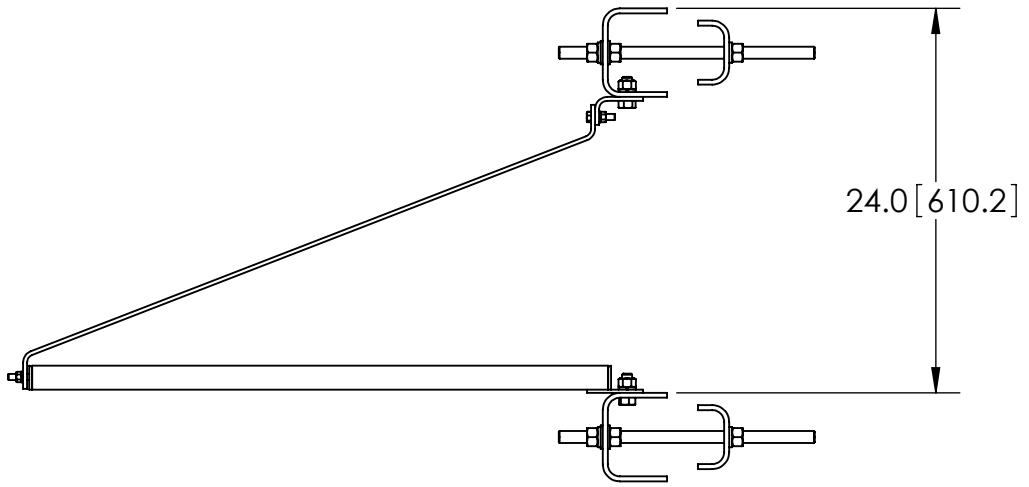
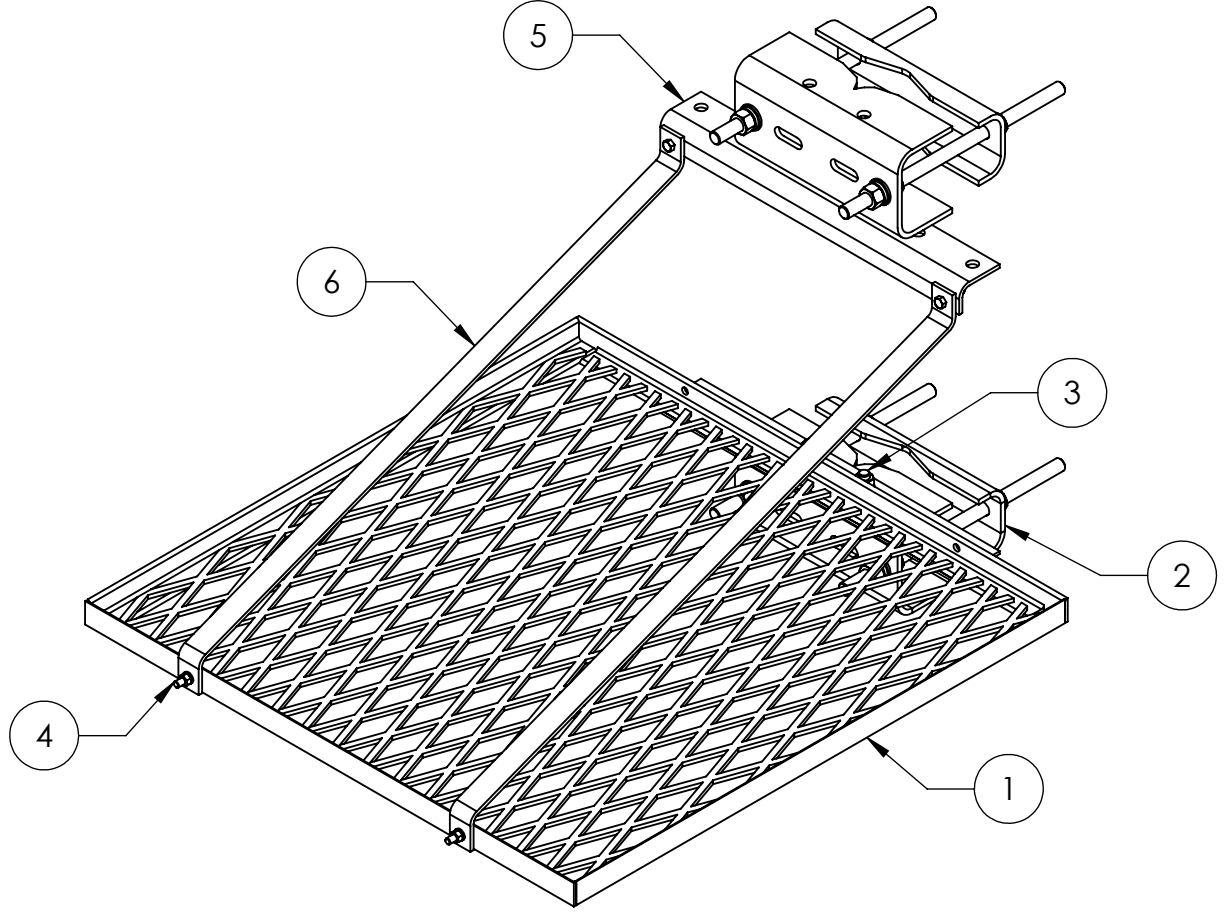
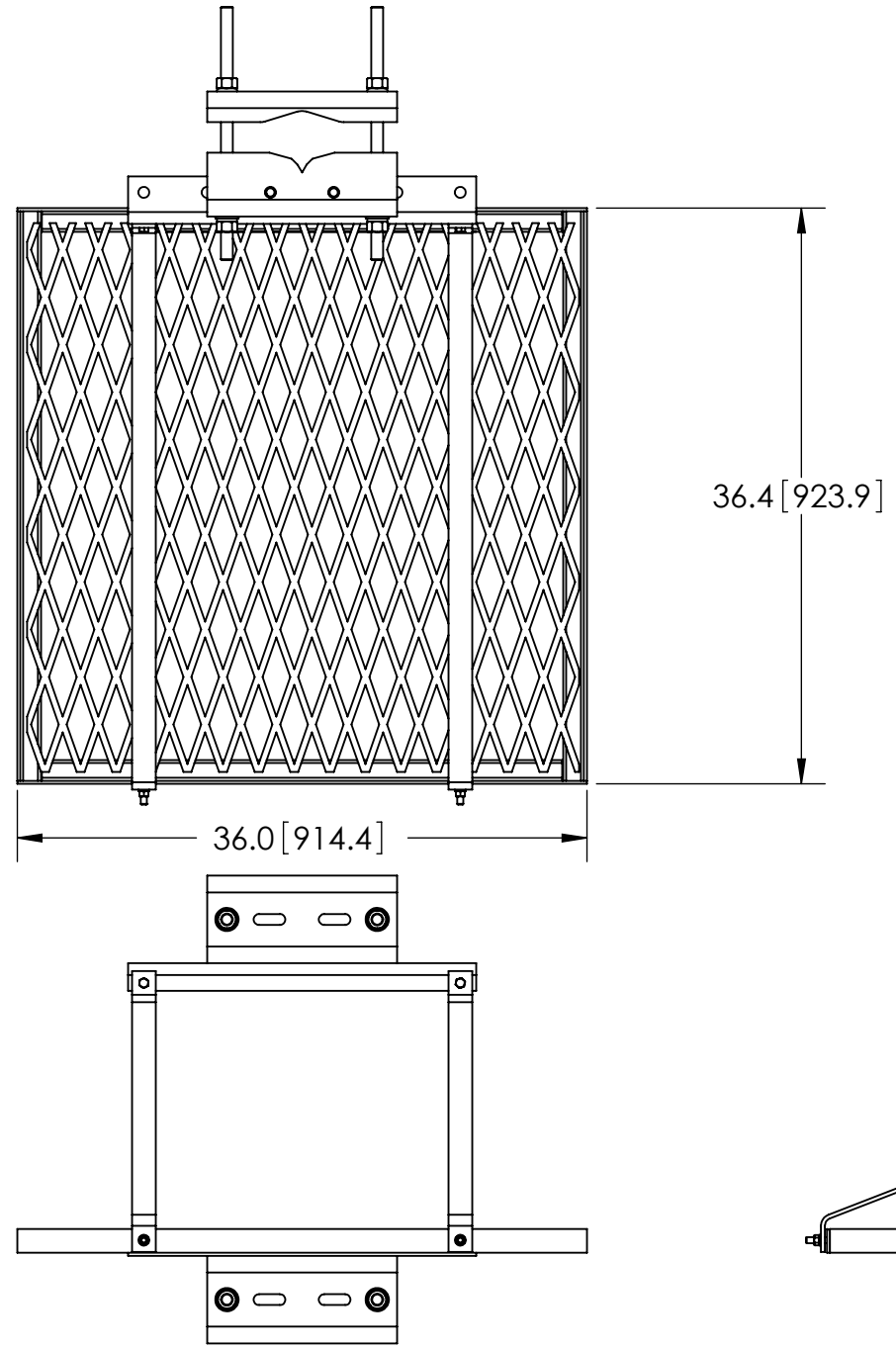

NOTES:
1. ALL METRIC DIMENSIONS ARE IN BRACKETS.

<small>These drawings and specifications are the proprietary property of ANDREW CORPORATION and may be used only for the specific purpose authorized in writing by Andrew Corporation.</small> ALL DIMENSIONS ARE IN INCHES U.O.S. TOLERANCES UNLESS OTHERWISE SPECIFIED: .X = ± .06 ANGLES ±2° .XX = ± .03 FRACTIONS ±1/32 .XXX = ± .010 REMOVE BURRS AND BREAK EDGES .005 DO NOT SCALE THIS PRINT	DRAWN BY: ACG	SHEET: 1 of 1	PART NUMBER: MD-SQ3
	CHECKED BY: TP	SCALE: NTS	DESCRIPTION: 3' Square Ice Shield Kit
	DATE: 03/27/10	MATERIAL: A36, A568	DRAWING TYPE: ASSEMBLY DRAWING
	REVISION: A	FINISH: GALV A123	WEIGHT: 152.37 LBS