

REV.	MCO	DWN	DATE
C	40019420MCO	EAAE	29-JAN-15
D	8000018817	SC	09-JAN-17

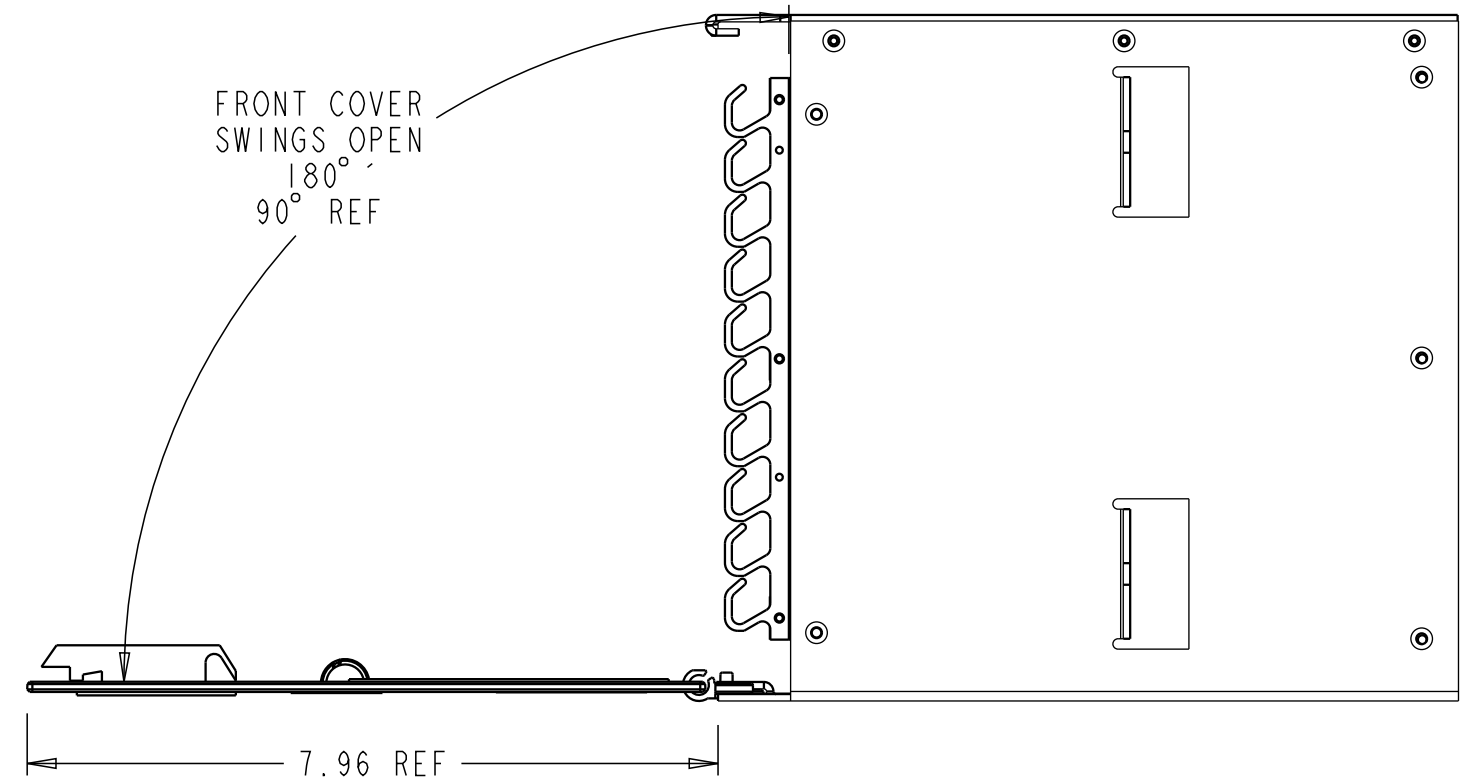
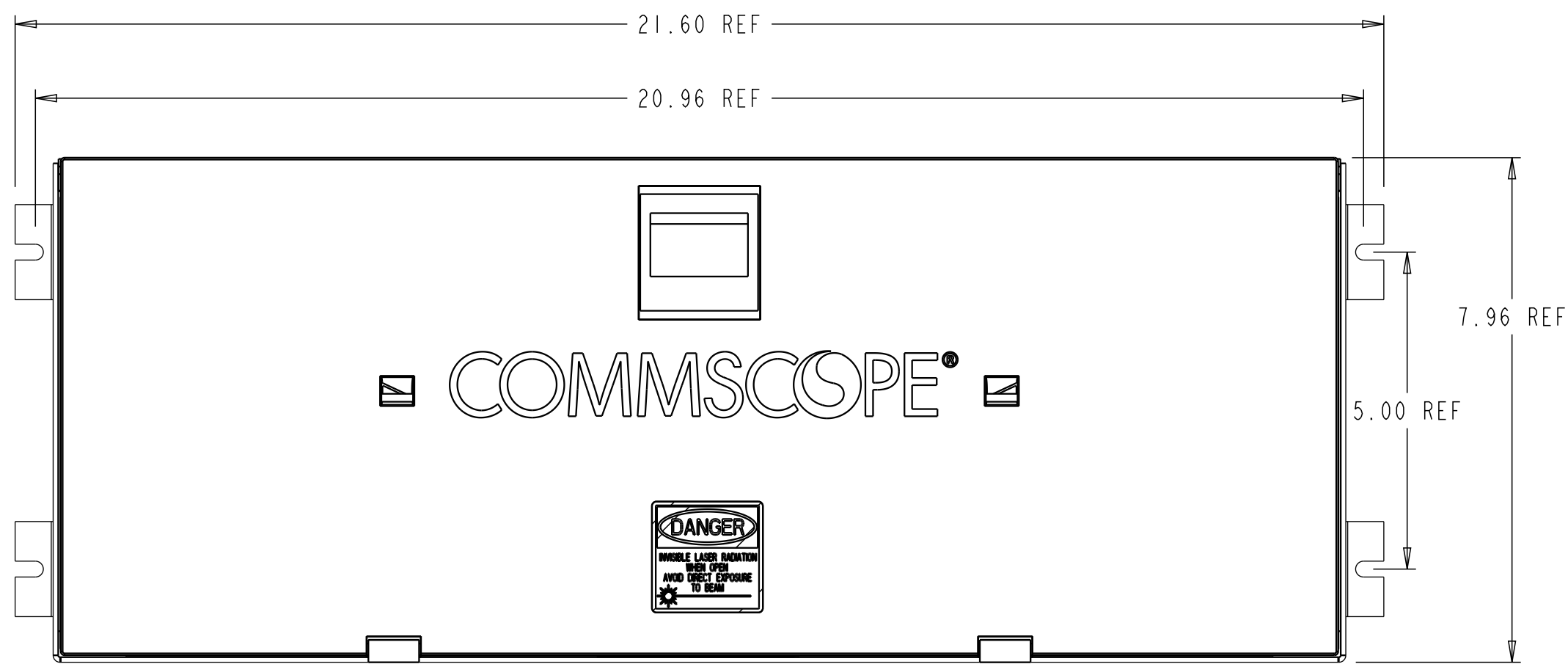
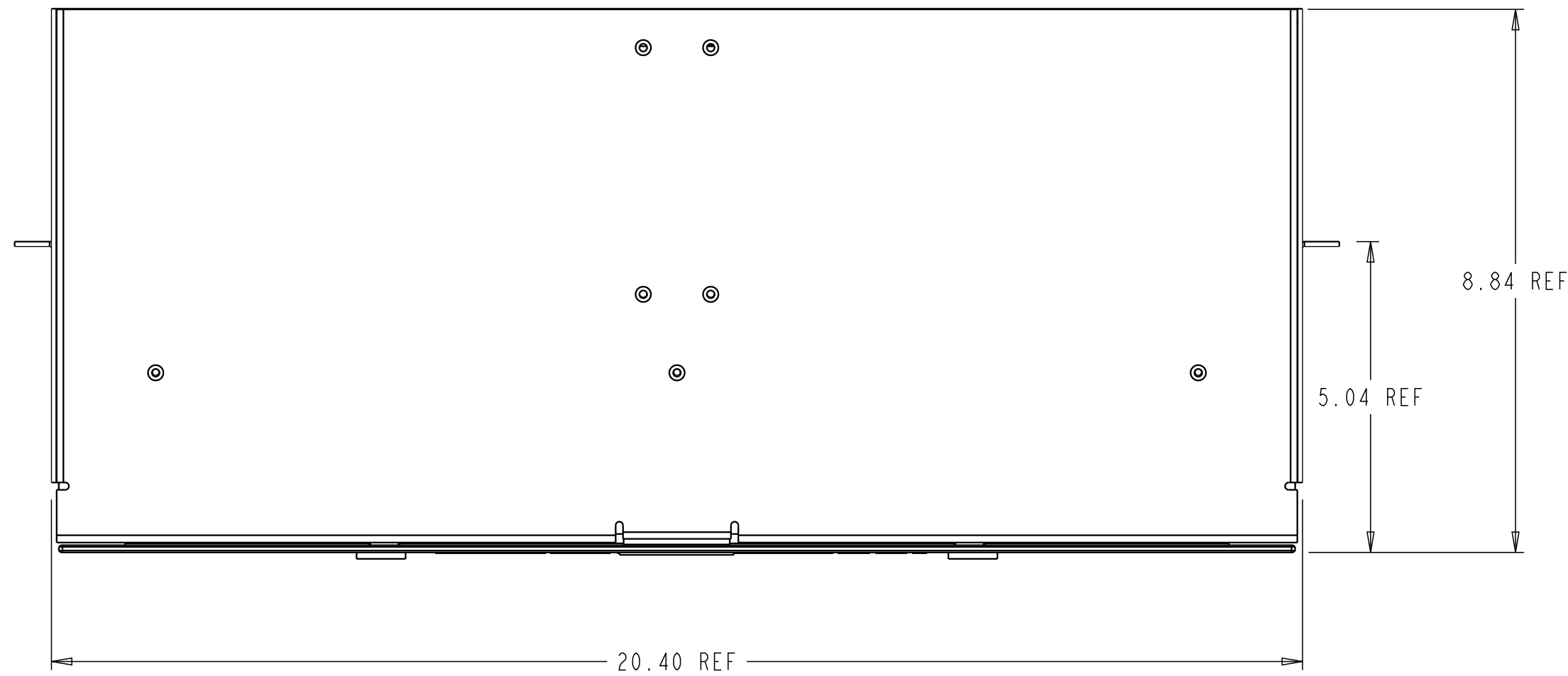
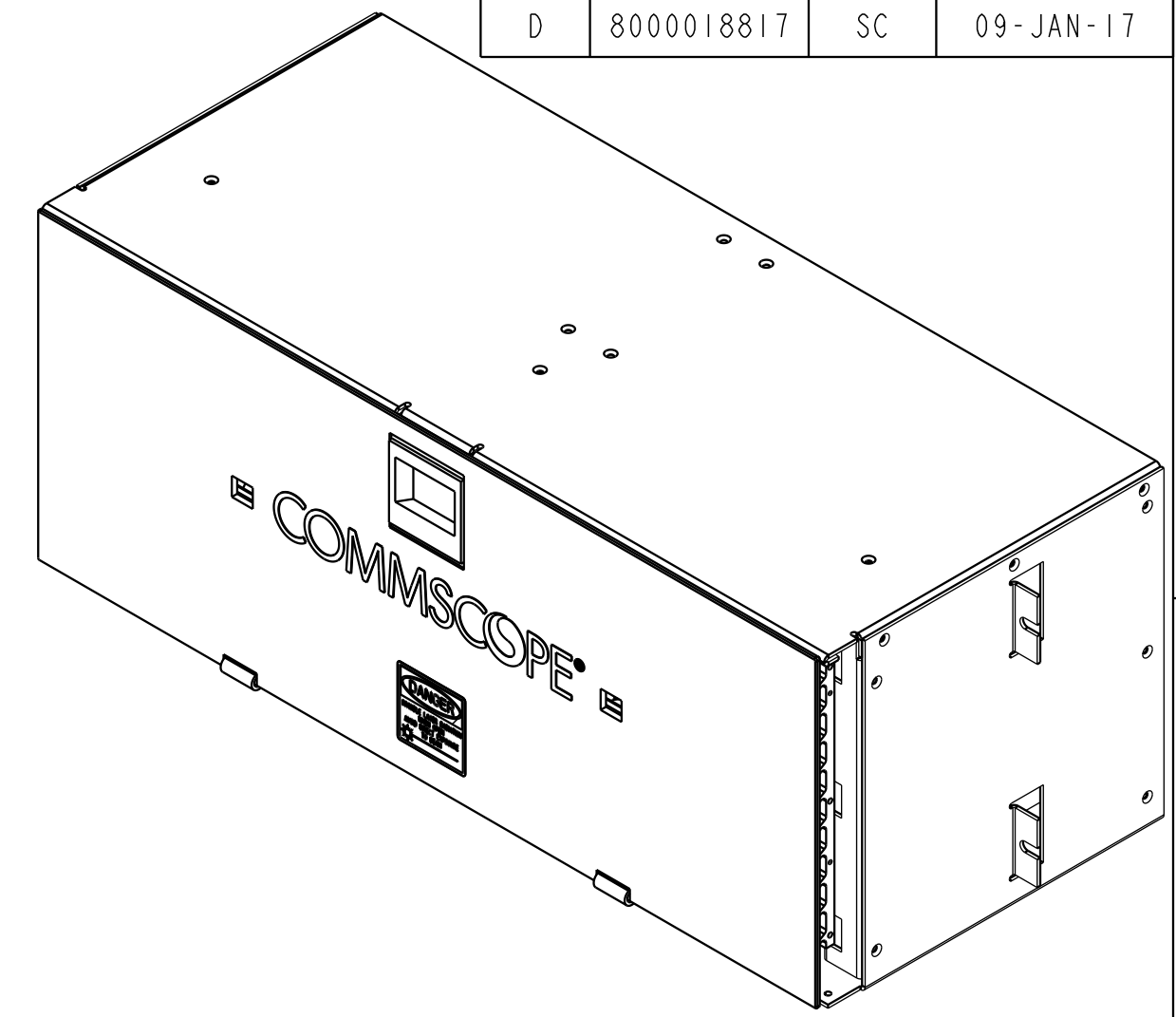

**NOTE:**

1. WHEN MOUNTING IN RACK, SLIDE CHASSIS INTO RACK FROM THE FRONT SIDE AND SECURE TO FRONT RACK FLANGE USING MOUNTING SCREWS.
2. DESIGNATION LABELS ARE INCLUDED WITH CHASSIS. SEE SHEET 2 FOR DESIGNATION LABEL USAGE.

COMMSCOPE, INC.

© 2016 COMMSCOPE, INC. CONFIDENTIAL  
 NOTICE: THESE DRAWINGS AND SPECIFICATIONS ARE THE PROPRIETARY PROPERTY OF COMMSCOPE, INC. AND MAY BE USED ONLY FOR THE SPECIFIC PURPOSE AUTHORIZED IN WRITING BY COMMSCOPE, INC.

ALL DIMS AND TOLERANCES ARE INCHES UNLESS OTHERWISE SPECIFIED  
 .XX:±N/A  
 .XXX:±N/A  
 ANGULAR:±N/A

DO NOT SCALE DRAWING

ENGR: SHARI VIGLIATURO  
 DWN: L. GONIER

TITLE		FDF-STDWVAM PRODUCT NUMBER	
WIDE VAM (INSTALLATION DRAWING)			
DRAWING NUMBER	C SIZE	D REV	
4-26860-3603			
SHT. 1 OF 2			

DIMENSIONS IN INCHES  
 THIRD ANGLE PROJECTION

POS 1 (REF)

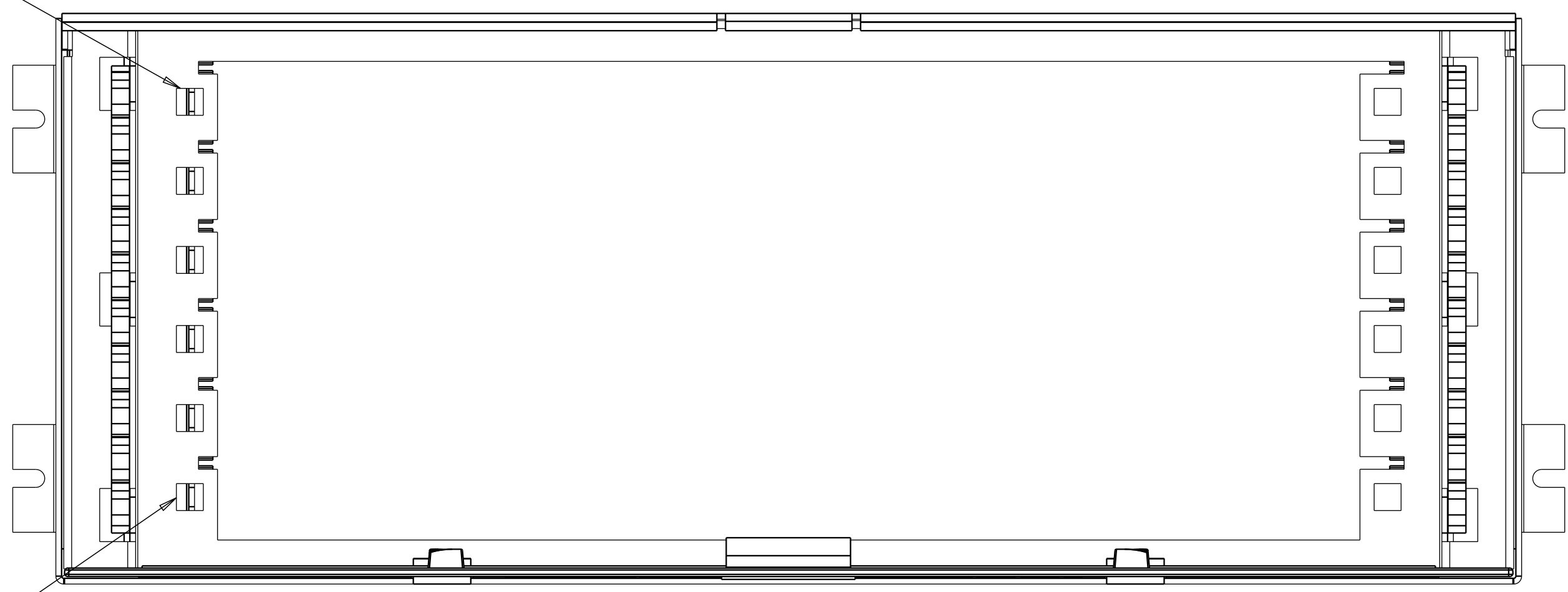

POS 6 (REF)

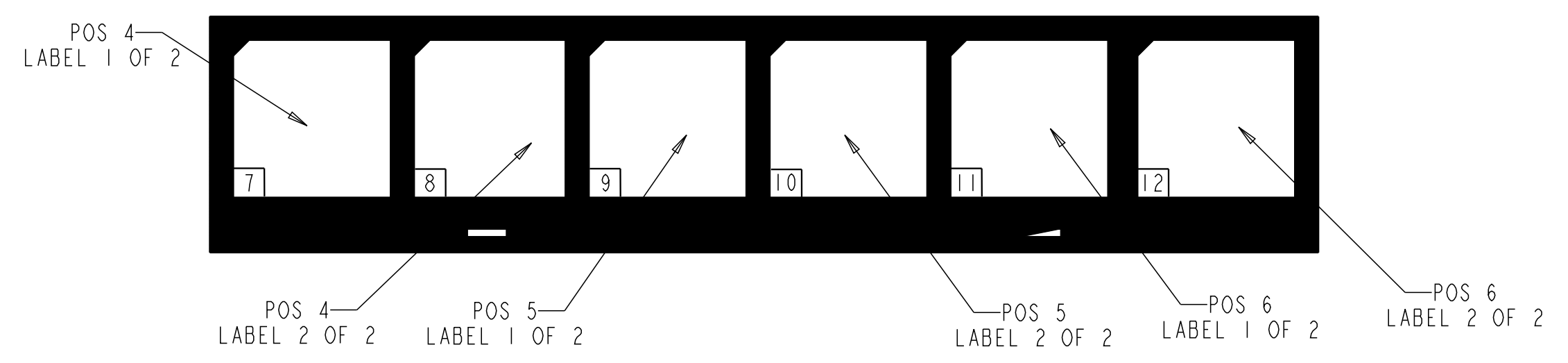
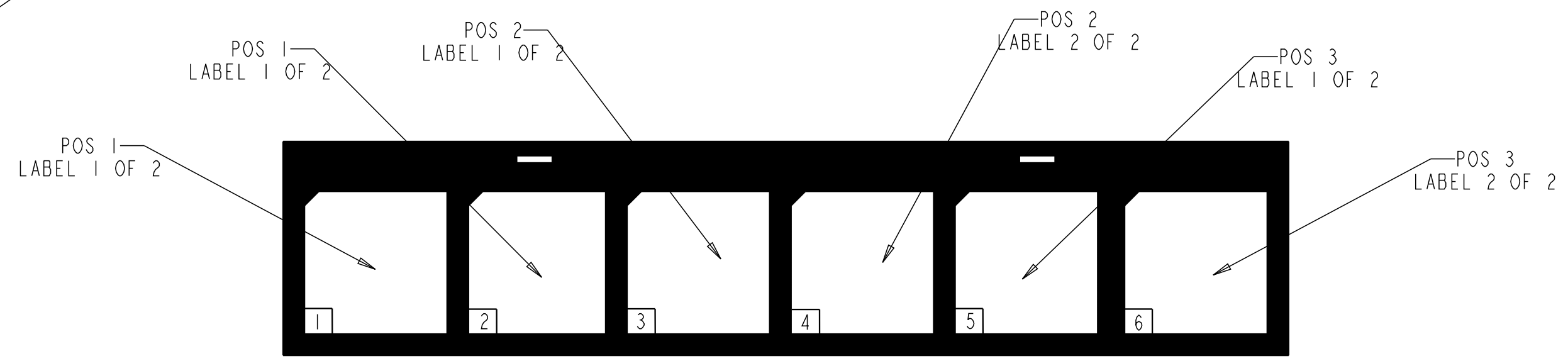

COMMSCOPE, INC.

© 2016 COMMSCOPE, INC. CONFIDENTIAL  
 NOTICE: THESE DRAWINGS AND SPECIFICATIONS  
 ARE THE PROPRIETARY PROPERTY OF  
 COMMSCOPE, INC. AND MAY BE USED ONLY FOR THE  
 SPECIFIC PURPOSE AUTHORIZED IN WRITING BY  
 COMMSCOPE, INC.

ALL DIMS AND TOLERANCES .XX:±N/A  
 ARE INCHES UNLESS .XXX:±N/A  
 OTHERWISE SPECIFIED ANGULAR:±N/A

DO NOT SCALE DRAWING

TITLE WIDE VAM (INSTALLATION DRAWING)		D
C	DRAWING NUMBER 4-26860-3603	REV
ENGR: SHARI VIGLIATURO		SHT. 2 OF 2
DWN: L. GONIER		



**DIMENSIONS IN INCHES  
 THIRD ANGLE PROJECTION**