

MATERIAL ID	DESCRIPTION
760200345	360CM 2X3 CONVERSION MODULE

NOTES:

1. SEE COMMSCOPE CATALOG FOR PART NUMBER SUFFIXES TO INDICATE COLOR/PKG.
2. SEE COMMSCOPE CATALOG FOR COMPLETE LIST OF PARTS RELATED TO THE USE OF THIS PRODUCT.
3. DIMENSIONS IN PARENTHESES ARE IN METRIC[MM].
4. PART INCLUDES:
(1) MODULE ASSEMBLY

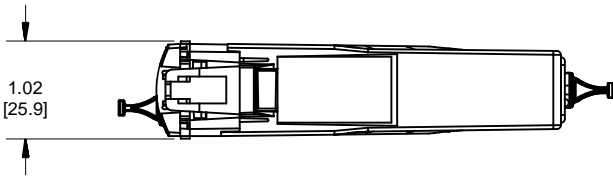
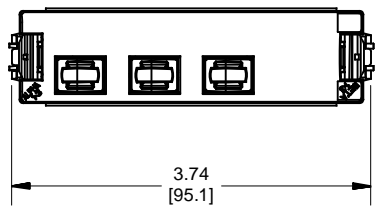
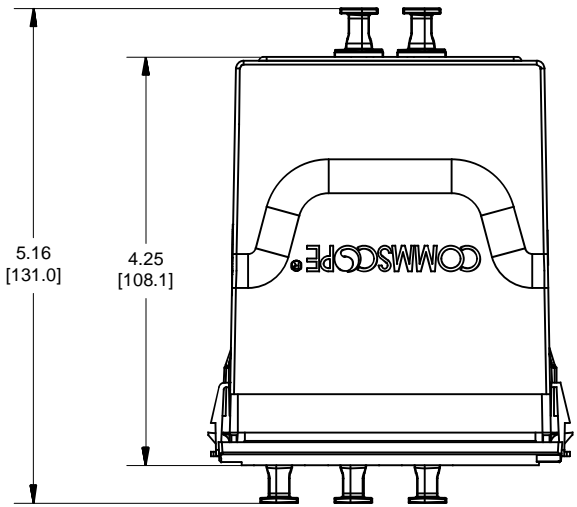

360CM-2x3-LS	
COMMSCOPE, INC OF NORTH CAROLINA	

1	5/07/15		INITIAL ISSUE	CTS	DRAWN BY JW	
REV	DATE	ECR	DESCRIPTION	APPROVED BY	DATE 4/15/2013	DWG NO 760200345