

NDX-D1BDMOU-A0600F



DLX® Fiber Indexing Terminal, no Splitter, 1 Forward Port, 1 Reverse Port, Dielectric Loose Tube Cable, 600 Feet

Product Classification

Regional Availability	North America
Product Type	Access terminal, indexed without splitter/tap
Product Brand	DLX®
Product Series	NDX

General Specifications

Cable Type	Dielectric - Flat - Loose Tube
Cable, quantity	1
Distribution Type	1 port
Enclosure Color	Black
Forward Port Type	Hardened mini-size (DLX) adapter
Forward Port, quantity	1
Mounting	Handhole Pedestal Pole
Port Type	Hardened multi-fiber (HMFOC) jack
Port, quantity	1
Reverse Port Type	Hardened mini-size DLX
Reverse Port, quantity	1
Splitter, quantity	0
Stub Type	Hardened multi-fiber (HMFOC) plug

Dimensions

Height	297.8 mm 11.724 in
Width	130.3 mm 5.13 in
Depth	90.4 mm 3.559 in

NDX-D1BDMOU-A0600F

Cable Stub Length	182.88 m 600 ft
Cable Outer Diameter	4.5 x 8.1 mm (0.18 x 0.32 in)

Dimension Drawing

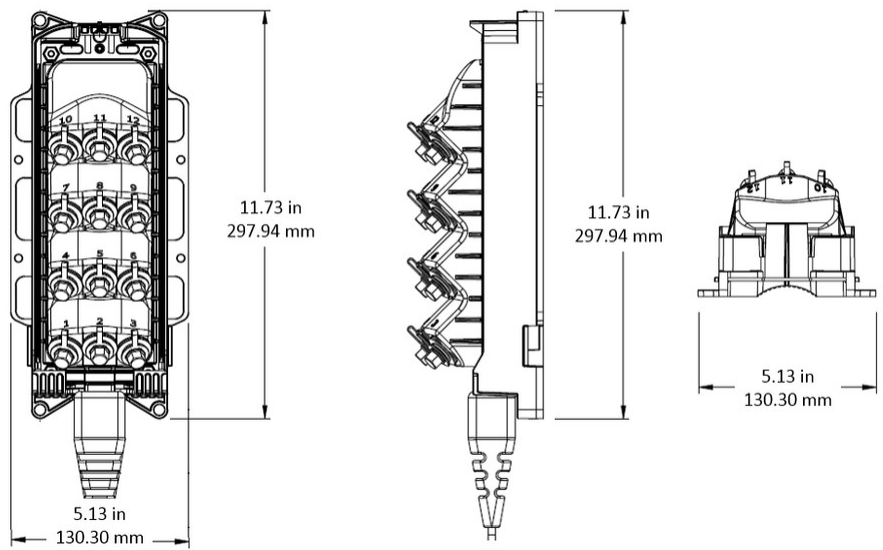

Ordering Tree

NDX-D1BDMOU-A0600F

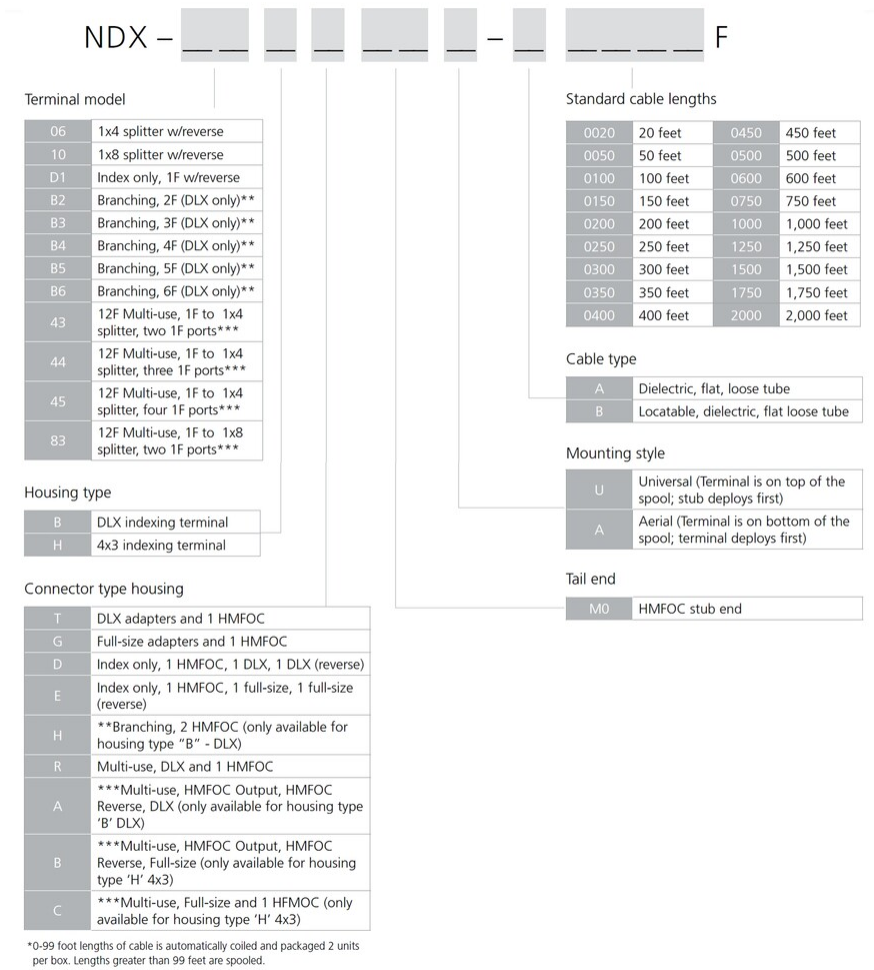

Material Specifications

Enclosure Material Type

Gasketed hardened plastic

Optical Specifications

Fiber Type

G.652.D

Operating Wavelength Range

1260 – 1635 nm

Attenuation Cable Coefficient, maximum

0.30 dB/km @ 1550 nm | 0.40 dB/km @ 1310 nm

Attenuation Terminal Connectors, maximum

0.45 dB

Directivity, minimum

60 dB

Insertion Loss, Stub Connector, maximum

0.45 dB

Insertion Loss, Stub Connector, typical

0.16 dB

Insertion Loss, Terminal Connector, typical

0.16 dB

NDX-D1BDMOU-A0600F

Return Loss, Connector, minimum 65 dB

Environmental Specifications

Operating Temperature -40 °C to +70 °C (-40 °F to +158 °F)
Relative Humidity 5%–100%, condensing
Environmental Space Above ground | Below ground | Buried
Flammability Rating UL 94 V-0
Qualification Standards IEC 60529, IP68 + 2 m waterhead | NEMA, Type 6 + 10 ft waterhead | Telcordia GR-3120-CORE | Telcordia GR-326-CORE | Telcordia GR-771-CORE
UV Resistance UV stabilized

Packaging and Weights

Included Enclosure (1) | Universal mounting bracket (1)
Packaging quantity 1
Packaging Type Box | Carton
Weight, without cable 1 kg | 2.205 lb

Regulatory Compliance/Certifications

Agency	Classification
CHINA-ROHS	Above maximum concentration value
ISO 9001:2015	Designed, manufactured and/or distributed under this quality management system
REACH-SVHC	Compliant as per SVHC revision on www.commscope.com/ProductCompliance
ROHS	Compliant/Exempted
UK-ROHS	Compliant/Exempted



Included Products

MST-UMB-MINI – DLX® Mini-MST, Fiber Optic Universal Mounting Bracket