

# MST-M8RH00-A0500UM



MST, Fiber Optic Multiport Service Terminal, 12-port with 1x8 splitter and 4 PtP ports, square 4x3 port, dielectric flat loose tube cable, 500 m

- Hardened connectors are factory-terminated and environmentally sealed for use in optical drop cable deployments
- Plug and play adapter ports ensure rapid cable installment in the outside plant access section of the network
- Multiport Service Terminals incorporate hardened connector technology that is designed to withstand the rugged outside plant environment

## Product Classification

<b>Regional Availability</b>	Asia   Latin America
<b>Product Type</b>	Access terminal, with splitter
<b>Product Series</b>	MST

## General Specifications

<b>Cable Type</b>	Dielectric - Flat - Loose Tube
<b>Cable, quantity</b>	1
<b>Distribution Type</b>	1 x 8 splitter
<b>Enclosure Color</b>	Black
<b>Mounting</b>	Handhole   Pedestal   Pole   Strand
<b>Port Type</b>	Hardened full-size SC/APC
<b>Port, quantity</b>	12
<b>Splitter, quantity</b>	1
<b>Stub Type</b>	Stub tail

## Dimensions

<b>Height</b>	286 mm   11.26 in
<b>Width</b>	188 mm   7.402 in
<b>Depth</b>	92.1 mm   3.626 in
<b>Cable Length, stub</b>	1642 ft (500 m)
<b>Cable Outer Diameter</b>	4.5 x 8.1 mm (0.18 x 0.32 in)

## Dimension Drawing

# MST-M8RH00-A0500UM

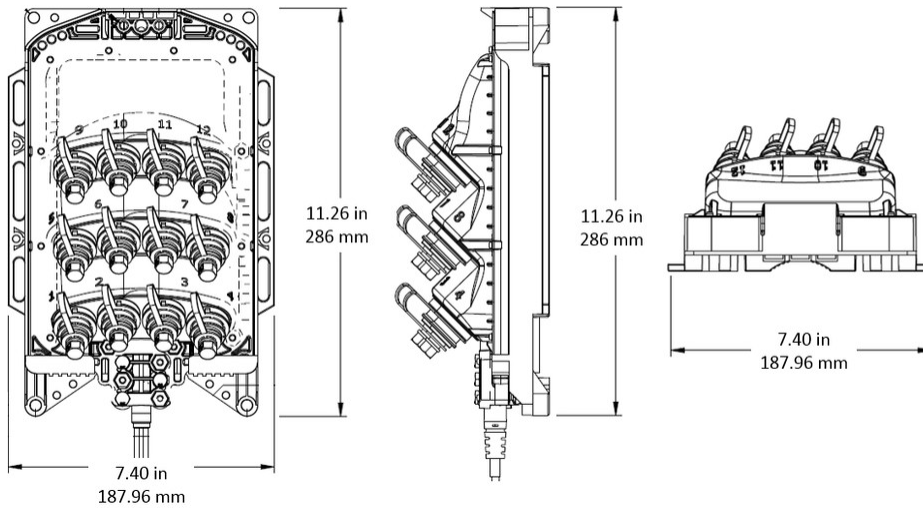

## Material Specifications

### Enclosure Material Type

Gasketed hardened plastic

## Optical Specifications

### Fiber Type

G.657.A1/A2

### Operating Wavelength Range

1260 – 1635 nm

### Attenuation Cable Coefficient, maximum

0.30 dB/km @ 1550 nm | 0.40 dB/km @ 1310 nm

### Attenuation Splitter, maximum

10.4 dB

### Attenuation Terminal Connectors, maximum

0.4 dB

### Directivity, minimum

60 dB

### Insertion Loss, Splitter, typical

10 dB

### Insertion Loss, Terminal Connector, typical

0.16 dB

### Return Loss, Connector, minimum

65 dB

### Return Loss, Single Ports, minimum

55 dB

## Environmental Specifications

### Operating Temperature

-40 °C to +70 °C (-40 °F to +158 °F)

### Relative Humidity

5%–100%, condensing

### Environmental Space

Above ground | Below ground | Buried

### Flammability Rating

UL 94 5VA

# MST-M8RH00-A0500UM

---

**Qualification Standards**

IEC 60529, IP68 + 2 m waterhead | Telcordia GR-3120-CORE | Telcordia GR-326-CORE | Telcordia GR-771-CORE

**UV Resistance**

UV stabilized

## Packaging and Weights

**Included**

Enclosure (1) | Optical splitter (1) | Universal mounting bracket (1)

**Packaging quantity**

1

**Packaging Type**

Box | Carton

**Weight, without cable**

1.36 kg | 2.998 lb

## Regulatory Compliance/Certifications

**Agency****Classification**

CHINA-ROHS

Below maximum concentration value

ISO 9001:2015

Designed, manufactured and/or distributed under this quality management system

REACH-SVHC

Compliant as per SVHC revision on [www.commscope.com/ProductCompliance](http://www.commscope.com/ProductCompliance)

ROHS

Compliant

UK-ROHS

Compliant/Exempted



## Included Products

MST-UMB-4312 - Universal MST Mounting Bracket

# MST-UMB-4312

---



## Universal MST Mounting Bracket

### Product Classification

<b>Regional Availability</b>	EMEA   Latin America   North America
<b>Product Type</b>	Mounting bracket
<b>Product Series</b>	MST   NDX

### General Specifications

<b>Color</b>	Black
--------------	-------

### Environmental Specifications

<b>Environmental Space</b>	Outdoor
----------------------------	---------

### Packaging and Weights

<b>Packaging quantity</b>	1
<b>Packaging Type</b>	Bag   Carton

### Regulatory Compliance/Certifications

<b>Agency</b>	<b>Classification</b>
CHINA-ROHS	Below maximum concentration value
REACH-SVHC	Compliant as per SVHC revision on <a href="https://www.commscope.com/ProductCompliance">www.commscope.com/ProductCompliance</a>
ROHS	Compliant
UK-ROHS	Compliant

