

# MST-12XX00-A0400UM



DLX® Mini-MST, Fiber Optic Multiport Service Terminal, 12-port, dielect. flat loose tube cable, 400 m

- Hardened connectors are factory-terminated and environmentally sealed for use in optical drop cable deployments
- Plug and play adapter ports ensure rapid cable installment in the outside plant access section of the network
- Multiport Service Terminals incorporate hardened connector technology that is designed to withstand the rugged outside plant environment

## Product Classification

|                              |                                       |
|------------------------------|---------------------------------------|
| <b>Regional Availability</b> | Asia   Latin America   North America  |
| <b>Product Type</b>          | Access terminal, without splitter/tap |
| <b>Product Brand</b>         | DLX®                                  |
| <b>Product Series</b>        | Mini-MST                              |

## General Specifications

|                           |                                     |
|---------------------------|-------------------------------------|
| <b>Cable Type</b>         | Dielectric - Flat - Loose Tube      |
| <b>Cable, quantity</b>    | 1                                   |
| <b>Distribution Type</b>  | 12 ports                            |
| <b>Enclosure Color</b>    | Black                               |
| <b>Mounting</b>           | Handhole   Pedestal   Pole   Strand |
| <b>Port Type</b>          | Hardened mini-size DLX              |
| <b>Port, quantity</b>     | 12                                  |
| <b>Splitter, quantity</b> | 0                                   |
| <b>Stub Type</b>          | Stub tail                           |

## Dimensions

|                             |                               |
|-----------------------------|-------------------------------|
| <b>Height</b>               | 298 mm   11.732 in            |
| <b>Width</b>                | 130.3 mm   5.13 in            |
| <b>Depth</b>                | 89 mm   3.504 in              |
| <b>Cable Length, stub</b>   | 1312 ft (400 m)               |
| <b>Cable Outer Diameter</b> | 4.5 x 8.1 mm (0.18 x 0.32 in) |

# MST-12XX00-A0400UM

## Dimension Drawing

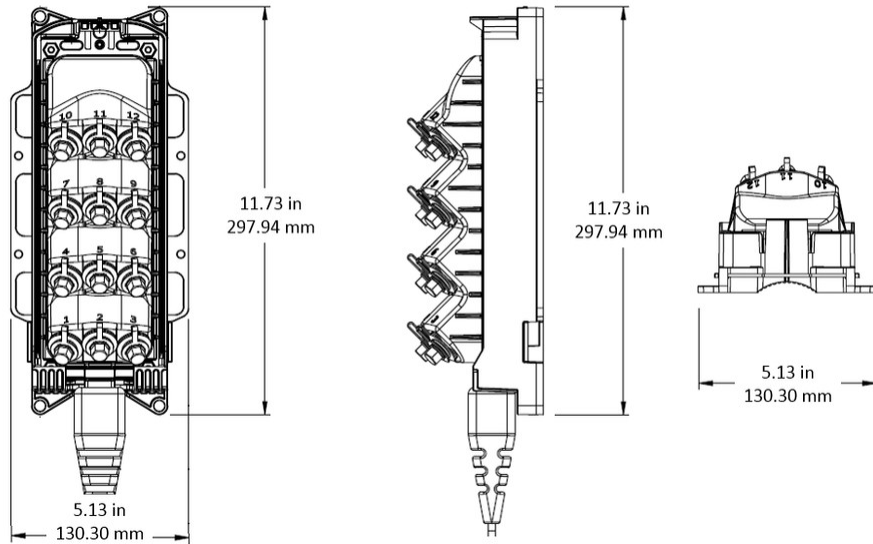

## Ordering Tree



## Material Specifications

**Enclosure Material Type**

Gasketed hardened plastic

## Optical Specifications

**Fiber Type**

G.657.A1/A2

# MST-12XX00-A0400UM

---

|  |   |
|--|---|
| <b>Operating Wavelength Range</b>                  | 1260 – 1635 nm                              |
| <b>Attenuation Cable Coefficient, maximum</b>      | 0.30 dB/km @ 1550 nm   0.40 dB/km @ 1310 nm |
| <b>Attenuation Terminal Connectors, maximum</b>    | 0.4 dB                                      |
| <b>Directivity, minimum</b>                        | 60 dB                                       |
| <b>Insertion Loss, Terminal Connector, typical</b> | 0.16 dB                                     |
| <b>Return Loss, Connector, minimum</b>             | 65 dB                                       |

## Environmental Specifications

|                                |  |
|--------------------------------|--|
| <b>Operating Temperature</b>   | -40 °C to +70 °C (-40 °F to +158 °F)   |
| <b>Relative Humidity</b>       | 5%–100%, condensing  |
| <b>Environmental Space</b>     | Above ground   Below ground   Buried   |
| <b>Flammability Rating</b>     | UL 94 V-0  |
| <b>Qualification Standards</b> | IEC 60529, IP68 + 2 m waterhead   Telcordia GR-3120-CORE   Telcordia GR-326-CORE   Telcordia GR-771-CORE |
| <b>UV Resistance</b>           | UV stabilized  |

## Packaging and Weights

|                              |  |
|------------------------------|--|
| <b>Included</b>              | Enclosure (1)   Universal mounting bracket (1) |
| <b>Packaging quantity</b>    | 1  |
| <b>Packaging Type</b>        | Box   Carton                                   |
| <b>Weight, without cable</b> | 0.99 kg   2.183 lb                             |

## Regulatory Compliance/Certifications

| <b>Agency</b> | <b>Classification</b>  |
|---------------|--|
| CHINA-ROHS    | Below maximum concentration value  |
| ISO 9001:2015 | Designed, manufactured and/or distributed under this quality management system   |
| REACH-SVHC    | Compliant as per SVHC revision on <a href="http://www.commscope.com/ProductCompliance">www.commscope.com/ProductCompliance</a> |
| ROHS          | Compliant  |
| UK-ROHS       | Compliant  |



## Included Products

MST-UMB-MINI – DLX® Mini-MST, Fiber Optic Universal Mounting

# MST-12XX00-A0400UM

---

Bracket