

MST-06RHM0-A0080UM

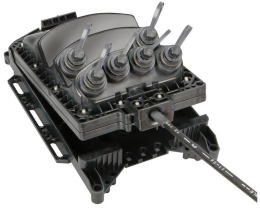

MST, Fiber Optic Multiport Service Terminal, 6-port, square 4x3 port, dielectric flat loose tube cable, HMFOC at far end, 80 m

- Hardened connectors are factory-terminated and environmentally sealed for use in optical drop cable deployments
- Plug and play adapter ports ensure rapid cable installment in the outside plant access section of the network
- Multiport Service Terminals incorporate hardened connector technology that is designed to withstand the rugged outside plant environment

Product Classification

Regional Availability	Asia Latin America North America
Product Type	Access terminal, without splitter/tap
Product Series	MST

General Specifications

Cable Type	Dielectric - Flat - Loose Tube
Cable, quantity	1
Distribution Type	6 ports
Enclosure Color	Black
Mounting	Handhole Pedestal Pole Strand
Port Type	Hardened full-size SC/APC
Port, quantity	6
Splitter, quantity	0
Stub Type	Hardened multi-fiber (HMFOC) plug

Dimensions

Height	414.5 mm 16.319 in
Width	188 mm 7.402 in
Depth	92.1 mm 3.626 in
Cable Length, stub	262 ft (80 m)
Cable Outer Diameter	4.5 x 8.1 mm (0.18 x 0.32 in)

Dimension Drawing

MST-06RHM0-A0080UM

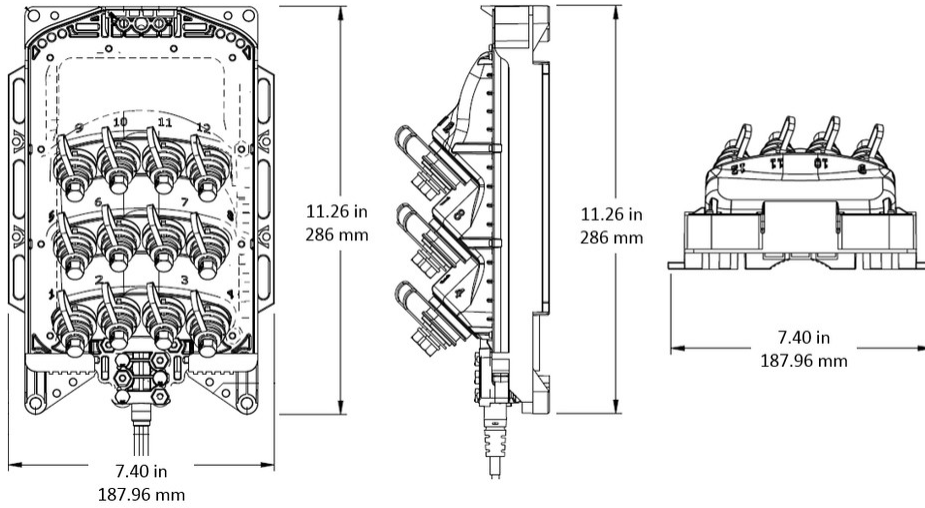

Ordering Tree

MST - R H 0 0 -

Terminal model

04	4 ports
06	6 ports
08	8 ports
12	12 ports
0N	1 x 4 splitter
0J	1 x 8 splitter

Cable type

A	Dielectric, flat, loose tube
B	Locatable, flat, loose tube

*0-300 ft lengths of cable is automatically coiled (option U), for greater than 300 ft cable lengths, choose U or A option.

Mounting style*

U	Universal: Terminal is on top of the spool; stub deploys first
A	Reversal spool: Terminal is on the bottom of the spool; terminal deploys first

Standard cable stub length

0050	50 feet
0100	100 feet
0200	200 feet
0500	500 feet
0750	750 feet
1000	1000 feet
1500	1500 feet
2000	2000 feet

Standard lengths shown; metric lengths available

Material Specifications

Enclosure Material Type

Gasketed hardened plastic

Optical Specifications

Fiber Type

G.657.A1/A2

Operating Wavelength Range

1260 – 1635 nm

Attenuation Cable Coefficient, maximum

0.30 dB/km @ 1550 nm | 0.40 dB/km @ 1310 nm

Attenuation Terminal Connectors, maximum

0.4 dB

MST-06RHMO-A0080UM

Directivity, minimum	60 dB
Insertion Loss, Stub Connector, maximum	0.45 dB
Insertion Loss, Stub Connector, typical	0.16 dB
Insertion Loss, Terminal Connector, typical	0.16 dB
Return Loss, Connector, minimum	65 dB

Environmental Specifications

Operating Temperature	-40 °C to +70 °C (-40 °F to +158 °F)
Relative Humidity	5%–100%, condensing
Environmental Space	Above ground Below ground Buried
Flammability Rating	UL 94 5VA
Qualification Standards	IEC 60529, IP68 + 2 m waterhead Telcordia GR-3120-CORE Telcordia GR-326-CORE Telcordia GR-771-CORE
UV Resistance	UV stabilized

Packaging and Weights

Included	Enclosure (1) Universal mounting bracket (1)
Packaging quantity	1
Packaging Type	Box Carton
Weight, without cable	1.36 kg 2.998 lb

Regulatory Compliance/Certifications

Agency	Classification
ISO 9001:2015	Designed, manufactured and/or distributed under this quality management system

Included Products

MST-UMB-4312 – Universal MST Mounting Bracket