

# MST-04MH00-B1000U



MST, Fiber Optic Multiport Service Terminal, 4-port, long 2xN port, locatable flat loose tube cable, 1000 ft

- Hardened connectors are factory-terminated and environmentally sealed for use in optical drop cable deployments
- Plug and play adapter ports ensure rapid cable installment in the outside plant access section of the network
- Multiport Service Terminals incorporate hardened connector technology that is designed to withstand the rugged outside plant environment

## Alternative products available:

HST-B4HNB1000NN000 HST, NOVUX™ Hardened Standard Terminal, 4-port, Flat toneable loose tube cable, 1000 ft/304 m

## Product Classification

<b>Regional Availability</b>	Asia   Latin America   North America
<b>Product Type</b>	Access terminal, without splitter/tap
<b>Product Series</b>	MST

## General Specifications

<b>Cable Type</b>	Locatable - Flat - Loose Tube
<b>Cable, quantity</b>	1
<b>Distribution Type</b>	4 ports
<b>Enclosure Color</b>	Black
<b>Mounting</b>	Handhole   Pedestal   Pole   Strand
<b>Port Type</b>	Hardened full-size SC/APC
<b>Port, quantity</b>	4
<b>Splitter, quantity</b>	0
<b>Stub Type</b>	Stub tail

## Dimensions

<b>Height</b>	282.4 mm   11.118 in
<b>Width</b>	129.5 mm   5.098 in
<b>Depth</b>	84.1 mm   3.311 in

# MST-04MH00-B1000U

<b>Cable Length, stub</b>	1000 ft (304 m)
<b>Cable Outer Diameter</b>	5.0 mm (0.20 in)

## Dimension Drawing

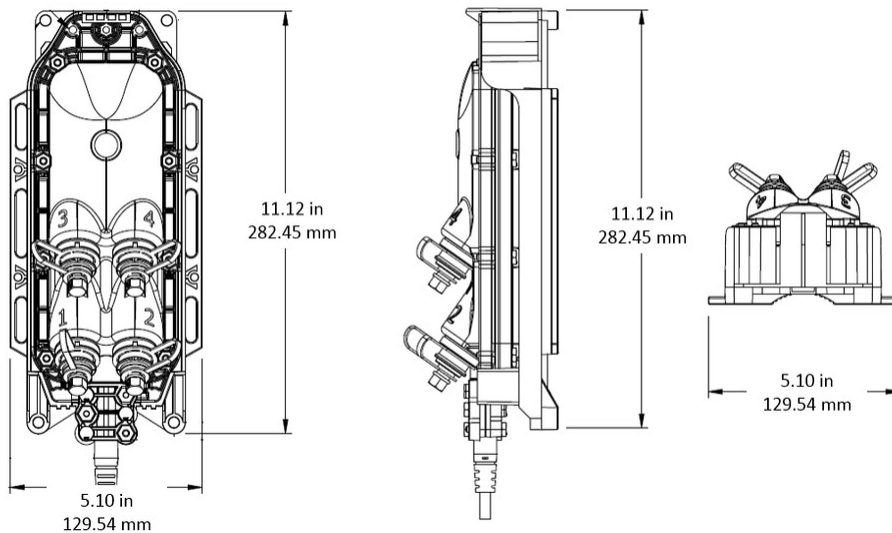

## Ordering Tree

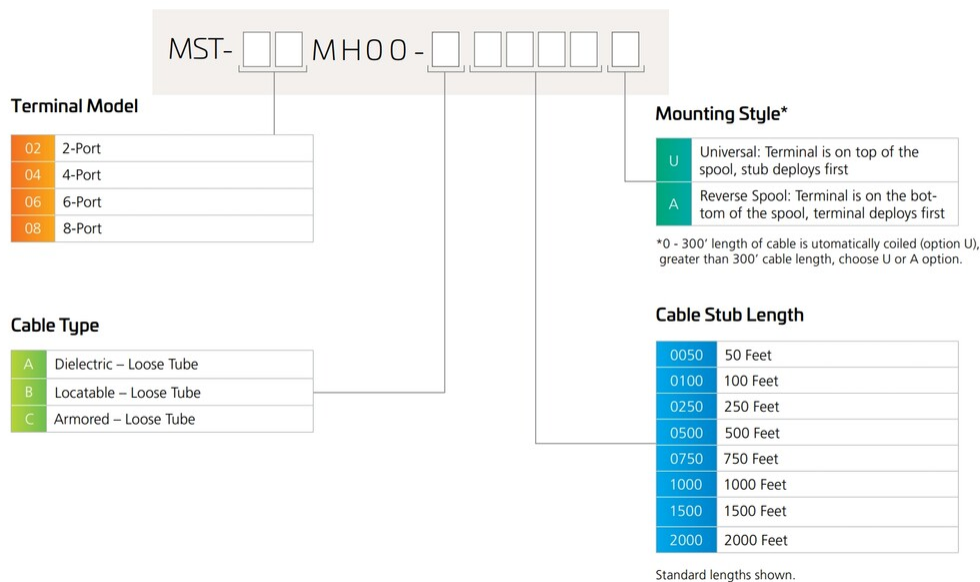

## Material Specifications

<b>Enclosure Material Type</b>	Gasketed hardened plastic
--------------------------------	---------------------------

# MST-04MH00-B1000U

---

## Optical Specifications

<b>Fiber Type</b>	G.657.A1/A2
<b>Operating Wavelength Range</b>	1260 – 1635 nm
<b>Attenuation Cable Coefficient, maximum</b>	0.30 dB/km @ 1550 nm   0.40 dB/km @ 1310 nm
<b>Attenuation Terminal Connectors, maximum</b>	0.4 dB
<b>Directivity, minimum</b>	60 dB
<b>Insertion Loss, Terminal Connector, typical</b>	0.16 dB
<b>Return Loss, Connector, minimum</b>	65 dB

## Environmental Specifications

<b>Operating Temperature</b>	-40 °C to +70 °C (-40 °F to +158 °F)
<b>Relative Humidity</b>	5%–100%, condensing
<b>Environmental Space</b>	Above ground   Below ground   Buried
<b>Flammability Rating</b>	UL 94 5VA
<b>Qualification Standards</b>	IEC 60529, IP68 + 2 m waterhead   Telcordia GR-3120-CORE   Telcordia GR-326-CORE   Telcordia GR-771-CORE
<b>UV Resistance</b>	UV stabilized

## Packaging and Weights

<b>Included</b>	Enclosure (1)   Universal mounting bracket (1)
<b>Packaging quantity</b>	1
<b>Packaging Type</b>	Box   Carton
<b>Weight, without cable</b>	0.86 kg   1.896 lb

## Regulatory Compliance/Certifications

<b>Agency</b>	<b>Classification</b>
CHINA-ROHS	Below maximum concentration value
ISO 9001:2015	Designed, manufactured and/or distributed under this quality management system
REACH-SVHC	Compliant as per SVHC revision on <a href="http://www.commscope.com/ProductCompliance">www.commscope.com/ProductCompliance</a>
ROHS	Compliant
UK-ROHS	Compliant



# MST-04MH00-B1000U

---

## Included Products

MST-UMB-0204 – MST, Fiber Optic Universal Mounting Bracket, 2/4 port

# MST-UMB-0204

---

MST, Fiber Optic Universal Mounting Bracket, 2/4 port



## Product Classification

<b>Regional Availability</b>	EMEA   Latin America   North America
<b>Product Type</b>	Mounting bracket
<b>Product Series</b>	MST

## General Specifications

<b>Color</b>	Black
--------------	-------

## Environmental Specifications

<b>Environmental Space</b>	Outdoor
----------------------------	---------

## Packaging and Weights

<b>Packaging quantity</b>	1
<b>Packaging Type</b>	Bag   Carton

## Regulatory Compliance/Certifications

<b>Agency</b>	<b>Classification</b>
CHINA-ROHS	Below maximum concentration value
REACH-SVHC	Compliant as per SVHC revision on <a href="https://www.commscope.com/ProductCompliance">www.commscope.com/ProductCompliance</a>
ROHS	Compliant
UK-ROHS	Compliant

