

MST-02MH00-A0500A



MST, Fiber Optic Multiport Service Terminal, 2-port, long 2xN port, dielectric flat loose tube cable stub, unterminated, reverse spool, 500 ft

- Hardened connectors are factory-terminated and environmentally sealed for use in optical drop cable deployments
- Plug and play adapter ports ensure rapid cable installment in the outside plant access section of the network
- Multiport Service Terminals incorporate hardened connector technology that is designed to withstand the rugged outside plant environment

Alternative products available:

HST-B2HNA0500NN001 HST, NOVUX™ Hardened Standard Terminal, 2-port, Dielectric flat loose tube cable, 500 ft/152 m, Reverse spool, terminal deploys first

Product Classification

| | |
|------------------------------|---------------------------------------|
| Regional Availability | Asia Latin America North America |
| Product Type | Access terminal, without splitter/tap |
| Product Series | MST |

General Specifications

| | |
|---------------------------|-------------------------------------|
| Cable Type | Dielectric - Flat - Loose Tube |
| Cable, quantity | 1 |
| Distribution Type | 2 ports |
| Enclosure Color | Black |
| Mounting | Handhole Pedestal Pole Strand |
| Port Type | Hardened full-size SC/APC |
| Port, quantity | 2 |
| Splitter, quantity | 0 |
| Stub Type | Stub tail |

Dimensions

| | |
|---------------|----------------------|
| Height | 282.4 mm 11.118 in |
| Width | 129.5 mm 5.098 in |
| Depth | 84.1 mm 3.311 in |

MST-02MH00-A0500A

| | |
|-----------------------------|-------------------------------|
| Cable Length, stub | 500 ft (152 m) |
| Cable Outer Diameter | 4.5 x 8.1 mm (0.18 x 0.32 in) |

Dimension Drawing



Ordering Tree

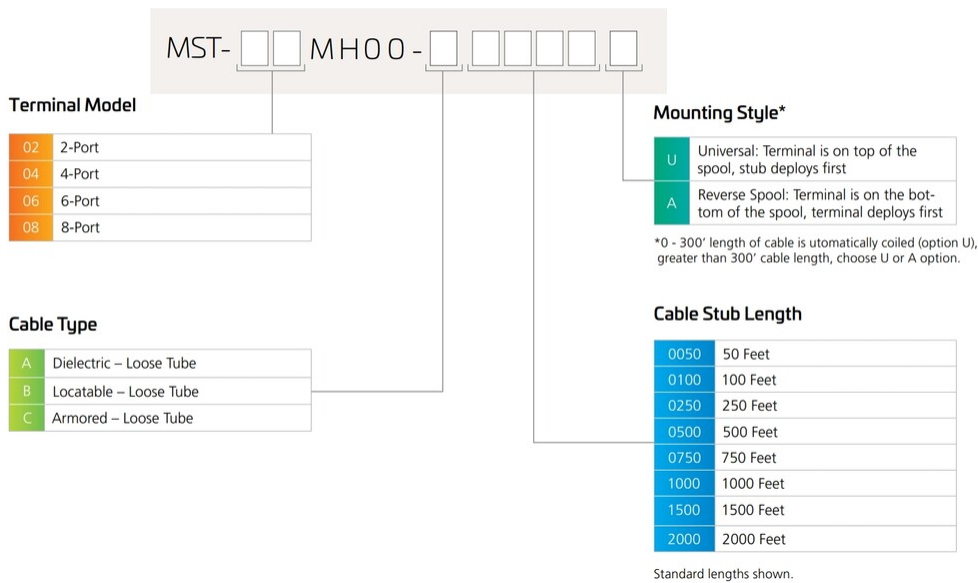

Material Specifications

| | |
|--------------------------------|---------------------------|
| Enclosure Material Type | Gasketed hardened plastic |
|--------------------------------|---------------------------|

MST-02MH00-A0500A

Optical Specifications

| | |
|--|---|
| Fiber Type | G.657.A1/A2 |
| Operating Wavelength Range | 1260 – 1635 nm |
| Attenuation Cable Coefficient, maximum | 0.30 dB/km @ 1550 nm 0.40 dB/km @ 1310 nm |
| Attenuation Terminal Connectors, maximum | 0.4 dB |
| Directivity, minimum | 60 dB |
| Insertion Loss, Terminal Connector, typical | 0.16 dB |
| Return Loss, Connector, minimum | 65 dB |

Environmental Specifications

| | |
|--------------------------------|--|
| Operating Temperature | -40 °C to +70 °C (-40 °F to +158 °F) |
| Relative Humidity | 5%–100%, condensing |
| Environmental Space | Above ground Below ground Buried |
| Flammability Rating | UL 94 5VA |
| Qualification Standards | IEC 60529, IP68 + 2 m waterhead Telcordia GR-3120-CORE Telcordia GR-326-CORE Telcordia GR-771-CORE |
| UV Resistance | UV stabilized |

Packaging and Weights

| | |
|------------------------------|--|
| Included | Enclosure (1) Universal mounting bracket (1) |
| Packaging quantity | 1 |
| Packaging Type | Box Carton |
| Weight, without cable | 0.86 kg 1.896 lb |

Regulatory Compliance/Certifications

| Agency | Classification |
|---------------|--|
| CHINA-ROHS | Below maximum concentration value |
| ISO 9001:2015 | Designed, manufactured and/or distributed under this quality management system |
| REACH-SVHC | Compliant as per SVHC revision on www.commscope.com/ProductCompliance |
| ROHS | Compliant |
| UK-ROHS | Compliant |



MST-02MH00-A0500A

Included Products

MST-UMB-0204 – MST, Fiber Optic Universal Mounting Bracket, 2/4 port

MST-UMB-0204

MST, Fiber Optic Universal Mounting Bracket, 2/4 port



Product Classification

| | |
|------------------------------|--------------------------------------|
| Regional Availability | EMEA Latin America North America |
| Product Type | Mounting bracket |
| Product Series | MST |

General Specifications

| | |
|--------------|-------|
| Color | Black |
|--------------|-------|

Environmental Specifications

| | |
|----------------------------|---------|
| Environmental Space | Outdoor |
|----------------------------|---------|

Packaging and Weights

| | |
|---------------------------|--------------|
| Packaging quantity | 1 |
| Packaging Type | Bag Carton |

Regulatory Compliance/Certifications

| Agency | Classification |
|---------------|---|
| CHINA-ROHS | Below maximum concentration value |
| REACH-SVHC | Compliant as per SVHC revision on www.commscope.com/ProductCompliance |
| ROHS | Compliant |
| UK-ROHS | Compliant |

