



BUDI™ Fiber Optic Wall mount Enclosure with FOSC Management System, 24 SC/APC ports

- Compact, wall mountable fiber enclosures for indoor and outdoor use
- Specifically designed for fast FTTH deployment and easy customer connection
- Available with splicing (FIST) and/or patching and/or splitter combinations
- Multiple and modular wrap around cable port sealing options

Product Classification

Regional Availability	North America
Product Type	Fiber wall box
Product Brand	BUDI™
Product Series	BUDI-FS

General Specifications

Functionality	Patching Splicing
Access	Front
Enclosure Color	Gray
Front Cover Type	Snap-on cover
Interface	SC/APC
Mounting	Wall
Port, quantity	24
Splicing Capacity, maximum	48

Dimensions

Height	425 mm 16.732 in
Height, with cover	500 mm 19.685 in
Width	295 mm 11.614 in
Depth	145 mm 5.709 in

Dimension Drawing

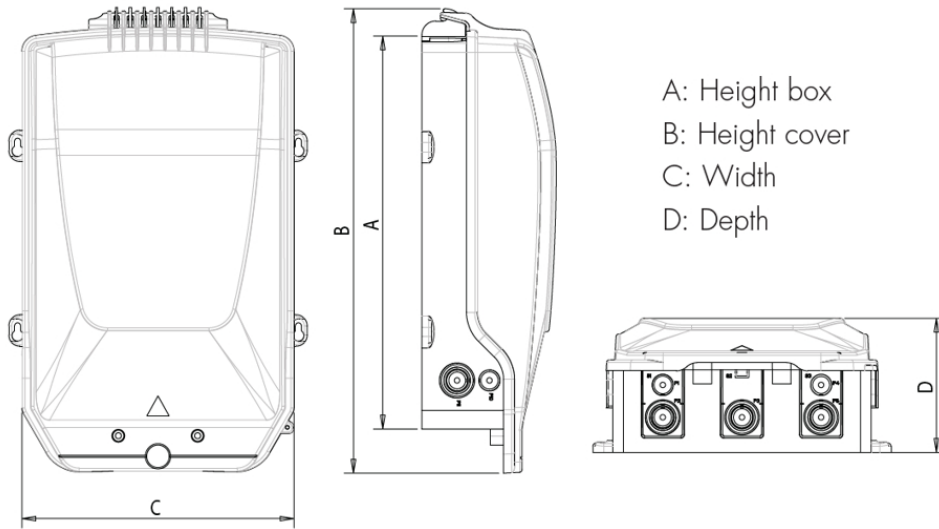

Material Specifications

Enclosure Material Type LSZH thermoplastic

Environmental Specifications

Environmental Space Indoor | Indoor/Outdoor

Qualification Standards IEC 60529, IP54 | IEC 61753-1, category G

Packaging and Weights

Included Cable seal | Pigtail seals | Splice tray

Packaging quantity 1

Packaging Type Box | Carton

Regulatory Compliance/Certifications

Agency	Classification
CHINA-ROHS	Above maximum concentration value
ROHS	Compliant/Exempted
UK-ROHS	Compliant/Exempted

