

Fiber Indoor Cable, LSZH Riser, All-Dielectric, Central Tube Ribbon, Multimode, OM3, bend insensitive, 48 Fibers, Gel-free, Feet jacket marking, Aqua jacket color

Product Classification

Regional Availability	Asia Australia/New Zealand EMEA Latin America North America
Portfolio	CommScope®
Product Type	Fiber indoor cable
Product Series	N-CN

General Specifications

Cable Type	Ribbon central tube
Construction Type	Non-armored
Subunit Type	Gel-free
Fibers per Ribbon, quantity	12
Jacket Color	Aqua
Jacket Marking	Feet
Total Fiber Count	48

Dimensions

Buffer Tube/Subunit Diameter	6 mm 0.236 in
Diameter Over Jacket	9.4 mm 0.37 in

Representative Image

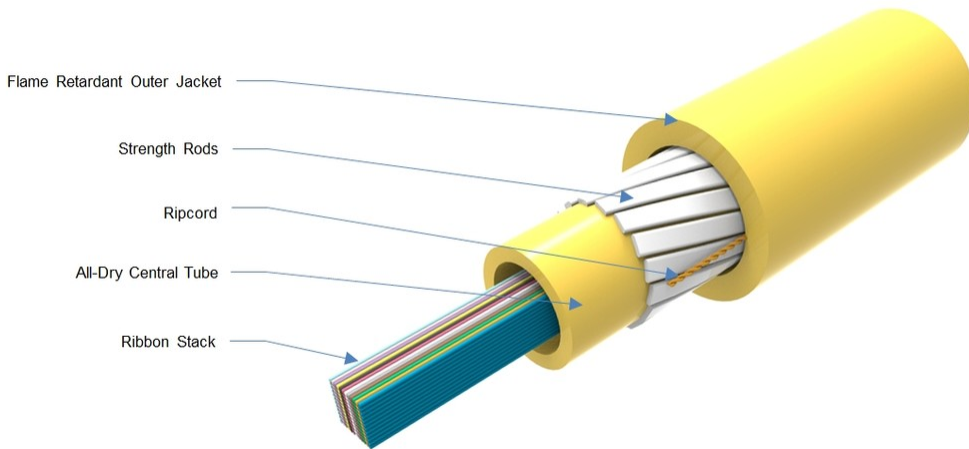

Mechanical Specifications

Minimum Bend Radius, loaded	188 mm 7.402 in
Minimum Bend Radius, unloaded	94 mm 3.701 in
Tensile Load, long term, maximum	334 N 75.086 lbf
Tensile Load, short term, maximum	1335 N 300.12 lbf
Compression	10 N/mm 57.101 lb/in
Compression Test Method	FOTP-41 IEC 60794-1 E3
Flex	25 cycles
Flex Test Method	FOTP-104 IEC 60794-1 E6
Impact	2.94 N-m 26.021 in lb
Impact Test Method	FOTP-25 IEC 60794-1 E4
Strain	See long and short term tensile loads
Strain Test Method	FOTP-33 IEC 60794-1 E1
Twist	10 cycles
Twist Test Method	FOTP-85 IEC 60794-1 E7

Optical Specifications

Fiber Type	OM3, bend insensitive OM3, bend insensitive
-------------------	---

Environmental Specifications

Installation temperature	0 °C to +70 °C (+32 °F to +158 °F)
Operating Temperature	-20 °C to +70 °C (-4 °F to +158 °F)

760212258 | N-048-CN-RB-F12AQ/5Y/99E

Storage Temperature	-40 °C to +70 °C (-40 °F to +158 °F)
Cable Qualification Standards	ANSI/ICEA S-83-596 Telcordia GR-409
Environmental Space	Low Smoke Zero Halogen (LSZH) Riser
Flame Test Listing	NEC OFNR-ST1 (UL) and c(UL)
Flame Test Method	IEC 60332-3 IEC 60754-2 IEC 61034-2 UL 1666 UL 1685

Environmental Test Specifications

Heat Age	-20 °C to +85 °C (-4 °F to +185 °F)
Heat Age Test Method	IEC 60794-1 F9
Low High Bend	-20 °C to +70 °C (-4 °F to +158 °F)
Low High Bend Test Method	FOTP-37 IEC 60794-1 E11
Temperature Cycle	-20 °C to +70 °C (-4 °F to +158 °F)
Temperature Cycle Test Method	FOTP-3 IEC 60794-1 F1

Packaging and Weights

Cable weight	90 kg/km 60.477 lb/kft
---------------------	--------------------------

Regulatory Compliance/Certifications

Agency	Classification
ISO 9001:2015	Designed, manufactured and/or distributed under this quality management system

Included Products

CS-5Y-RB	- 50µm OM3 Bend-Insensitive Multimode Fiber
----------	---

* Footnotes

Operating Temperature Specification applicable to non-terminated bulk fiber cable